



DECEMBER 1994

**FM 100-23
PEACE
OPERATIONS**

DISTRIBUTION RESTRICTION:
Approved for public release; distribution is unlimited.

HEADQUARTERS
DEPARTMENT OF THE ARMY

PEACE OPERATIONS

CONTENTS

	PREFACE	iii
	INTRODUCTION	iv
Chapter 1	FUNDAMENTALS OF PEACE OPERATIONS	1
	The Strategic Context	1
	The Types of Operations	2
	The Variables	12
	The Principles	15
	The Tenets	18
Chapter 2	COMMAND, CONTROL, COORDINATION, AND LIAISON	20
	Command and Support Relationships	21
	Unilateral Operations	21
	Multinational Operations	21
	United Nations Operations	23
	Non-United Nations Operations	26
	Humanitarian Assistance	26
	Interagency Operations	29
	Liaison	29

DISTRIBUTION RESTRICTION: Approved for public release; distribution is unlimited.

Chapter 3	PLANNING CONSIDERATIONS.....	31
	Mission Analysis	31
	Campaign Plan	31
	Use of Force	33
	Force Protection	36
	Force Training	38
	Force Tailoring.....	38
	Combat Functions	39
	Public Affairs Considerations.....	47
	Legal Considerations	48
Chapter 4	LOGISTICS	50
	Logistics-Preparation-of-the Theater	50
	Shared Logistics	52
	Resource Management	56
	Logistics Functions	56
Appendix A	THE UNITED NATIONS	61
Appendix B	UNITED STATES GOVERNMENT, UNITED NATIONS, AND OTHER INTERNATIONAL ORGANIZATIONS.....	76
Appendix C	TRAINING.....	86
Appendix D	SAMPLE RULES OF ENGAGEMENT	90
Appendix E	SAMPLE CAMPAIGN PLAN	97
	GLOSSARY.....	101
	REFERENCES	118
	INDEX	124

Preface

This manual provides guidance for the full range of peace operations, to include support to diplomacy (peacemaking, peace building, and preventive diplomacy), peacekeeping (PK), and peace enforcement (PE). It addresses the environment of peace operations, related concepts, principles, and fundamentals, to include planning, operational considerations, training, and supporting functions. This manual is for commanders and staffs charged with the responsibility for peace operations to assist them in planning and conducting operations. It is also useful to nonmilitary agencies and foreign military units conducting related operations.

This manual supports soldiers and leaders who execute peace operations. It serves as the foundation for further development of US Army tactics, techniques, and procedures (TTPs) manuals and refinement of existing training support packages (TSPs), mission training plans (MTPs), training center and unit exercises, and service school curricula. It drives the examination of organizations and materiel developments applicable to peace operations.

Commanders will face ambiguous situations and uncertainty in peace operations. They are obligated to set clear objectives, define the mission, firmly guide operations, and measure progress and success. In order to assist commanders and their staffs, this manual explains the principles and tenets of peace operations and their applications; describes likely peace operations; and discusses command, control, coordination, and liaison requirements and other unique planning considerations. It also provides information concerning the UN and other organizations that may participate in peace operations.

This manual incorporates lessons learned from recent peace operations and existing doctrine to provide a framework for development in the conduct of peace operations. It builds on the discussions of peacekeeping and peace enforcement in FM 100-5¹ and applies to operations conducted by Army forces in joint, multinational, or interagency environments. It outlines selected considerations for linkages between Army units and certain nongovernmental and international organizations involved in such operations.

The basis of this manual is the US Army's expertise in conducting missions on land as a demonstration of US resolve and commitment to international peace, security, and stability. It provides guidelines for implementation of deterrence and compellance measures during peace operations in support of US National Security Strategy (NSS), National Military Strategy (NMS), and US policy.

The proponent of this manual is HQ TRADOC. Send comments and recommendations on DA Form 2028 directly to Commander, US Army Training and Doctrine Command, ATTN: ATDO-A, Fort Monroe, VA 23651-5000.

Unless this publication states otherwise, masculine nouns and pronouns do not refer exclusively to men.

¹. *Operations*, 14 June 1993.

Introduction

It must be peace without victory. . . .

Woodrow Wilson

*We are now concerned with the peace of the entire world
and the peace can only be maintained by the strong.*

General George C. Marshall

*Properly constituted, peace operations can be one useful tool
to advance American national interests and pursue
our national security objectives.*

The Clinton Administration's Policy on
Reforming Multinational Peace Operations
May 1994

Today's world, with changing patterns of conflict and threats to US interests, presents new political and military challenges. It also presents extraordinary opportunities. The existence of instability and potential threats require a strong military capability sufficiently versatile to execute national military strategy across the full range of operations—to include *war* and *operations other than war* (OOTW).

Recognizing these realities, the 1993 version of the Army's keystone manual on operations, FM 100-5, devoted a chapter to OOTW. That chapter includes a broad discussion of PK and PE. This manual focuses specifically on peace operations, building on the foundation laid in FM 100-5.

This manual provides the basis for planning and executing peace operations. As doctrine, this manual guides the Army in how to think about peace operations and provides fundamentals for these operations.

THE HISTORY

Peace operations is a new and comprehensive term that covers a wide range of activities. Peace operations create and sustain the conditions necessary for peace to flourish. Peace operations comprise three types of activities: *support to diplomacy* (peacemaking, peace building, and preventive diplomacy), *peacekeeping*, and *peace enforcement*. Peace operations include traditional peacekeeping as well as peace enforcement activities such as protection of humanitarian assistance, establishment of order and stability, enforcement of sanctions, guarantee and denial of movement, establishment of protected zones, and forcible separation of belligerents.

Peace operations have become increasingly common in the post-Cold War strategic security environment. For example, in its first 40 years, the United Nations (UN) conducted only 13 such operations, all relatively small, with the exception of UN operations in the Congo during

the 1960s. Since 1988, the number of peace operations has more than doubled, with each succeeding one being more complex than the last. The UN's peacekeeping operation in Cambodia in 1993, for example, included 22,000 military, police, and civilian personnel from 32 contributing nations. The operation cost the world community well over \$2 billion. The UN-sanctioned peace operation in Somalia (unified task force [UNITAF]), spearheaded by the US, involved more than 27,000 personnel from 23 contributing nations at a cost of \$750 million.

Peace operations are not new to the Army. Since 1948, US soldiers have served in many such operations—to include the United Nations Truce Supervisory Organization in the Middle East, Lebanon (1958), the Dominican Republic (1965), and the Sinai (since 1982)—as members of a multinational force and observers (MFO).

What is new is the number, pace, scope, and complexity of recent operations. For example, in 1993, six separate peace operations were conducted or authorized by the UN in the former Yugoslavia. They included missions to enforce sanctions against all belligerent parties, to deny aerial movement, to protect humanitarian assistance in Bosnia, to establish protected zones, and to establish a preventive deployment to the former Yugoslav Republic of Macedonia (FYROM). Commanders must understand the dynamics of peace operations and how actions taken in one operation may affect the success of another. In recent years, on any given day, thousands of soldiers were deployed to conduct or support peace operations in places such as Somalia, FYROM, the Sinai, and Croatia.

THE ENVIRONMENT

Peace operations often take place in environments less well-defined than in war. The identity of belligerents may be uncertain and the relationship between a specific operation and a campaign plan may be more difficult to define than would normally be the case in war. On the other hand, the relationship between specific peace operations and political objectives may be more sensitive, direct, and transparent.

US forces involved in peace operations may not encounter large, professional armies or even organized groups responding to a chain of command. Instead, they may have to deal with loosely organized groups of irregulars, terrorists, or other conflicting segments of a population as predominant forces. These elements will attempt to capitalize on perceptions of disenfranchisement or disaffection within the population. Criminal syndicates may also be involved.

The close link desired by such elements and the civilian population-at-large means the traditional elements of combat power, such as massive firepower, may not apply to peace operations. The nonviolent application of military capabilities, such as civil-military information and psychological operations (PSYOP) may be more important.

An overemphasis on firepower may be counterproductive. Because of the potential linkages between combatants and noncombatants, the political and cultural dimensions of the battlefield become more critical to the conflict. When force must be used, its purpose is to protect life or compel, not to destroy unnecessarily; the conflict, not the belligerent parties, is the enemy.

THE MEASURE OF SUCCESS

As with any mission, commanders at all levels must have a common understanding of the end state and the conditions that constitute success prior to initiating operations. In peace operations, *settlement*, not victory, is the ultimate measure of success, though settlement is

rarely achievable through military efforts alone. Peace operations are conducted to reach a resolution by conciliation among the competing parties, rather than termination by force. Peace operations are designed principally to create or sustain the conditions in which political and diplomatic activities may proceed. In peace operations, military action must complement diplomatic, economic, informational, and humanitarian efforts in pursuing the overarching political objective. The concept of traditional military victory or defeat is inappropriate in peace operations.

CHAPTER 1

Fundamentals of Peace Operations

The prime focus of the Army is warfighting, yet the Army's frequent role in operations other than war is critical.

Versatility is to the decathlete as agility is to the boxer.

FM 100-5

*Peacekeeping is not a job for soldiers,
but only a soldier can do it.*

Former UN Secretary-General Dag Hammerskold

This chapter provides a doctrinal framework for peace operations. It is not a detailed template but an authoritative statement and guide for conducting peace operations. Adaptable to the diverse and varied nature of peace operations, this chapter describes the strategic context of such operations, to include unilateral and multinational operations. The chapter includes information on the variables of peace operations, the principles of peace operations, and the tenets of Army peace operations. It defines the different types of peace operations and establishes an operational context for each.

THE STRATEGIC CONTEXT

Because peace operations are usually conducted in the full glare of worldwide media attention, the strategic context of a peace operation must be communicated and understood by all involved in the operation. Soldiers must understand that they can encounter situations where the decisions they make at the tactical level have immediate strategic and political implications. In addition to the overall strategic and political context of the operation, soldiers should be aware of the area's history, economy, culture, and any other significant factors. Failure to fully understand the mission and operational environment can quickly lead to incidents and misunderstandings that will reduce legitimacy and consent and result in actions that are inconsistent with the overall political objective.

Member nations of the United Nations (UN) conduct peace operations under the provisions of Chapters VI and VII of the *UN Charter*.¹ The

US reserves the right to conduct operations unilaterally in conformance with appropriate international law. In such cases, the US would organize, equip, and employ its forces consistent with the unique aspects of these two chapters of the *UN Charter*. See Appendix A for a general description of UN organization and functions.

Normally, traditional peacekeeping (PK) involving high levels of consent and strict impartiality are operations authorized under the provisions of Chapter VI of the *UN Charter*, which discusses the peaceful settlement of disputes. Thus, PK operations are often referred to as *Chapter VI operations*.

Peace operations with low levels of consent and questionable impartiality are conducted

¹ Chapter VI, "Pacific Settlement of Disputes" and Chapter VII, "Action With Respect to Threats to the Peace, Breaches of the Peace, and Acts of Aggression," *Charter of the United Nations*, 26 June 1945.

under mandates governed by Chapter VII of the *UN Charter*. Chapter VII operations are frequently referred to collectively as *PE* (peace enforcement). Because Chapter VII is so broad—including action with respect to acts of aggression—some operations, such as the UN operations in Korea (1950-1953) and in Kuwait and Iraq (1990-1991), are also referred to as *PE*. However, from a doctrinal view, these two operations are clearly wars and must not be confused with *PE* as described herein.

THE TYPES OF OPERATIONS

Peace operations encompass three types of activities: support to diplomacy, peacekeeping, and peace enforcement. The definitions of these terms, although precise, must be viewed in a world beset with imprecise and ambiguous situations. So, it is more useful to understand the principles of peace operations and the types of forces required to deal with them.

SUPPORT TO DIPLOMACY

Military support to diplomacy has become increasingly important in furthering US interests abroad. The components of support to diplomacy include peacemaking, peace building, and preventive diplomacy. Support to diplomacy takes place in peace or conflict and is conducted to prevent conflict. Military actions contribute to and are subordinate to the diplomatic peacemaking process. Many of these actions are the typical, day-to-day operations conducted by the military as part of its peacetime mission. The stationing of military forces abroad as part of a forward presence may contribute to stability and the creation of conditions necessary for the peaceful resolution of disputes.

Peacemaking

Peacemaking is a process of diplomacy, mediation, negotiation, or other forms of peaceful settlement that end disputes and resolve the issues that led to conflict. Military activities that support peacemaking include military-to-military relations and security assistance operations. Other military activities, such as exercises and peacetime deployments, may enhance the diplomatic process by demonstrating the engagement of the US abroad. These activities contribute to

an atmosphere of cooperation and assistance with allies and friends, thus demonstrating the resolve of the US with regard to its commitments. Such demonstrations of resolve may assist diplomatic efforts at conflict resolution. Military-to-military contacts and security assistance programs also serve to enhance diplomacy by influencing important groups in regions of conflict and by promoting the stable environment necessary for the success of diplomacy.

Peace Building

Peace building consists of postconflict actions, primarily diplomatic, that strengthen and rebuild civil infrastructures and institutions in order to avoid a return to conflict. It also includes mechanisms that advance a sense of confidence and well-being and support economic reconstruction. Military as well as civilian involvement is normally required. Peace building activities include restoring civil authority, rebuilding physical infrastructures, and reestablishing commerce, schools, and medical facilities. The most extensive peace-building effort in history took place in Europe and Asia in the post-World War II era when the US and its allies assisted nations in those continents devastated by a decade of war.

Military support to diplomacy also includes assistance in selected areas such as the conduct of elections and plebiscites and demobilization of former belligerent parties. Nation assistance is another activity of support to diplomacy. It may occur prior to or after a conflict, although the UN term pertains primarily to postconflict activities.

Preventive Diplomacy

Preventive diplomacy involves diplomatic actions taken in advance of a predictable crisis to prevent or limit violence. In more tense situations, military activities may support preventive diplomacy. Such support may include preventive deployments, other shows of force, or higher levels of readiness. The objective is to demonstrate resolve and commitment to a peaceful resolution while underlining the readiness and ability of the US to use force if required.

Preventive deployment is the deployment of military forces to deter violence at the interface

or zone of potential conflict where tension is rising among parties. The use of preventive deployment does not rely on a truce or a peace plan agreed to among parties. Although forces or observers will deploy with the consent or at the request of one or all parties involved, their specific tasks may not have been agreed to, except in principle, among parties (see Figure 1-1). Usually these deployments will employ forces in such a way that they are indistinguishable from a PK force in terms of equipment, force posture, and activities.

Preventive deployments can be used in—

- Internal or national crises, at the request of the government or parties concerned.
- Interstate disputes, at the request of one or more of the parties concerned.

A preventive deployment force may execute tasks similar to those conducted by early warning observers. By deploying in greater numbers

and with greater authority, this force can insist on gaining access to areas of potential conflict. In principle, tactical surveillance and monitoring capability, as well as the symbolic presence of such a force, act as a restraining influence. The underlying concept of a preventive deployment is that under the critical scrutiny of the international community, parties will be under pressure to consider negotiation before resorting to violence. The tasks of a preventive deployment force may include—

- Acting as an interpositional force to forestall violence.
- Protecting the local delivery of humanitarian relief.
- Assisting local authorities to protect and offer security to threatened minorities, to secure and maintain essential services (water, power), and to maintain law and order.

Figure 1-1. Former Yugoslav Republic of Macedonia Command

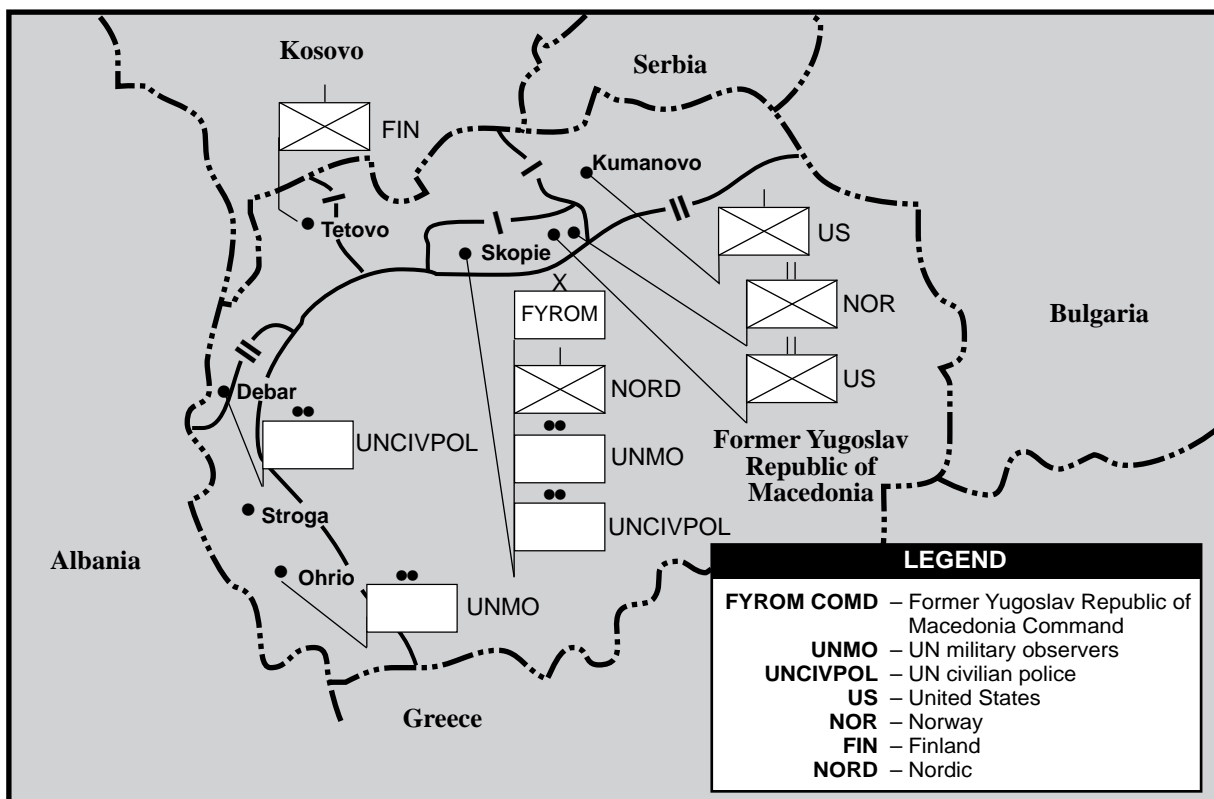

A preventive deployment may be composed of several national contingents in the same manner as a conventional PK force. Soldiers may carry weapons necessary for protective tasks as well as for self-defense. Deployed civilians may carry weapons for self-defense only if authorized by the field commander after receiving proper training. The minimal capabilities of a preventive deployment force may be enhanced by the presence of an offshore or regional coalition strike force. The strike force will have the capability to protect the preventive deployment force. The presence of a strike force will influence negotiations as well as security of deployed forces on the ground.

A preventive deployment force may act in order to ensure access to an area of operation (AO). Actions may include—

- Observing and reporting on developments in the AO.
- Patrolling and securing a border or demarcation line.
- Presenting a show of force in order to dissuade a potential aggressor.

The employment of forces in support of a preventive deployment will normally involve combat, combat support (CS), and combat service support (CSS) units. A reinforcement capability will normally be maintained in the immediate region. Units charged with this activity should have a high degree of tactical mobility, coupled with significant surveillance and communication capabilities.

PEACEKEEPING

PK involves military or paramilitary operations that are undertaken with the consent of all major belligerent parties. These operations are designed to monitor and facilitate implementation of an existing truce agreement and support diplomatic efforts to reach a long-term political settlement. The multinational force and observers (MFO) operation in the Sinai provides a classic example of a force conducting a PK operation. PK activities include observation and monitoring of truces and cease-fires and supervision of truces.

Observation and Monitoring of Truces and Cease-Fires

Individual military personnel may be called upon to observe, monitor, verify, and report that parties to a conflict comply with the commitments into which they enter, such as truces and cease-fires. They may also be called upon to monitor a developing situation and report on events to the authorizing authority. Soldiers involved in such activities are called observers or monitors. Observers and monitors execute their duties under the authority of an international agreement or a mandate. They must be impartial and responsible to the authorizing authority.

The role of observers engaged in battlefield stabilization or confidence-building measures among regular armed forces involved in conflict has been extensively developed since the establishment of the first such organization—the United Nations Truce Supervision Organization (UNTSO)—in 1948. Observers and monitors are most commonly deployed on an individual basis and normally form military observer groups with individuals from other nations. Some tasks, such as liaison, may be performed individually. Observers and monitors are armed or unarmed as the situation dictates. Civilian officials of international organizations or governments may also serve as observers and monitors.

The employment of observers in an early warning role to report on a developing situation is another aspect of this mission. These observers may serve to deter aggression by reporting timely information about a potentially tense situation. Observers and monitors may also be selectively employed to oversee certain types of events, such as elections, in order to verify their validity.

Reporting and Monitoring. Military observers report accurate and timely military information in their assigned sector of responsibility. Initially, observers may be required to report on the withdrawal of armed forces as belligerent parties begin the disengagement process. Subsequently, observers may monitor the interface among those forces, to include any demilitarized lines or areas. Observers and monitors do not act to

interpose themselves between belligerent parties.

Supervision. Observers may be called upon to carry out numerous types of supervisory tasks. Observers do not normally act with regard to violations. They merely observe and report. These tasks include supervision of—

- Cease-fire lines, borders, buffers, demilitarized zones, restricted areas, enclaves, and other geographic entities.
- The execution of the provisions of treaties, truces, cease-fires, arms control agreements, and other binding agreements.
- The exchange of prisoners of war, civilians, human remains, and territory.
- Refugee camps, collection points, and stations.
- Censuses, referendums, plebiscites, and elections.

Investigation of Complaints and Violations. Observers may be required to conduct investigations of complaints and alleged violations of the provisions of an agreement. Such investigations must be carried out in a completely impartial manner.

Negotiation and Mediation. Observers may be required to undertake negotiations on behalf of all parties to the conflict and to act as mediators among the parties to a dispute. Observers must be prepared to supervise any actions undertaken to remedy the situation. Impartiality is critical to the performance of these tasks; observers must be seen as part of the solution, not part of the problem.

Liaison. Observers may function as liaison officers with the mission of maintaining personal contact and exchanging information with any of a number of entities. These may include the belligerent parties, the host nation, local civilian officials, international agencies, higher headquarters, and other military units.

Supervision of Truces

Military formations normally conduct truce supervision operations. Such formations are introduced into a conflict area to fulfill a specific

mandate in order to permit diplomatic negotiations to take place in a conflict-free environment. These operations are possible only with the consent of the disputing parties.

Truce supervisory forces operate in significantly greater numbers than observers. Rather than simply monitoring the situation, truce supervisory forces can insist that the local population comply with the specific conditions of a *peace agreement*. Truce supervisory forces can, for example, patrol in sensitive areas, investigate installations or vehicles for prohibited items, and establish movement control points.

Truce supervisory forces may be used to supervise a peace or cease-fire agreement. Supervision of a truce is also known as *traditional PK*, even when no formal peace has been signed. In traditional PK, truce supervisory forces physically interpose themselves between the disputing parties. In such cases, they may occupy a disengagement line or buffer zone at the interface between the belligerent parties.

Military forces that conduct truce supervisory operations are normally multinational, while subformations are usually exclusively national. Military forces supervising truces are generally armed with organic small arms. However, forces may deploy with other weapons systems, based on the threat.

These forces will normally commence operations once a truce, cease-fire, or peace has been agreed to and the situation has stabilized. Truce supervisory forces may be required to supervise the disengagement and withdrawal of belligerent forces. Supervision actions are similar to those conducted by observers and monitors, but with the added requirement of maintaining the ability to supervise the terms of the mandate. Liaison tasks are likewise similar to those of observers and monitors.

Intermediary tasks may require truce supervisory forces to act as a credible and impartial intermediary among belligerent parties. Such mediation is accomplished through negotiations on contentious issues or incidents to arrive at a mutually acceptable solution that will maintain the conditions of the mandate. Superior negotiating skills are critical to the successful accomplishment of these actions.

Assistance activities by truce supervisory forces may include the requirement to provide humanitarian assistance (HA) within the AO. In addition, truce supervisory forces may be required to supervise demobilization and demilitarization measures subsequent to a peace treaty. In certain unstable situations, these forces may be required to provide a measure of law, order, and stability on an interim basis until competent civil authority can reestablish authority.

PEACE ENFORCEMENT

PE is the application of military force or the threat of its use, normally pursuant to international authorization, to compel compliance with generally accepted resolutions or sanctions. The purpose of PE is to maintain or restore peace and support diplomatic efforts to reach a long-term political settlement.

PE may include combat action. In such cases, missions must be clear and end states defined. With the transition to combat action comes the requirement for the successful application of

HISTORICAL PERSPECTIVE

During the early days of the United Nations Force in Cyprus (UNFICYP), the UN force sector commanders had to physically place themselves and their units between armed irregular Cypriot Greek and Turkish forces to prevent the spark that might have destroyed the shaky peace. Their presence, along with sometimes lengthy negotiations, made clear to the would-be belligerent parties that shooting was no longer an acceptable action.

warfighting skills. Thus, in a theater of operations both combat and noncombat actions may occur simultaneously. Forces conducting PE may, for example, be involved in the forcible separation of belligerent parties or be engaged in combat with one or all parties to the conflict. US



PE may include combat action. In such cases, missions must be clear and end states defined. Transition to combat requires the successful application of warfighting skills.

participation in operations in Somalia in 1992 and 1993 is an example of PE. The following elements apply to all PE operations.

- *Phases.* PE operations are normally conducted in several phases. The first phase may involve the insertion of rapidly deployable combat forces in order to establish a significant and visible military presence. Subsequent phases will involve the transition from a military presence to support for the development of competent civil authority.
- *Forces.* The forces employed for such operations will be armed and equipped based on commanders' estimates and METT-T. Infantry units, supported by engineer, military police, and aviation assets, are most often employed in this role. They are normally reinforced by civil affairs (CA) and psychological operations (PSYOP) assets.
- *Missions.* The missions assigned to PE forces include the restoration and maintenance of order and stability, protection of humanitarian assistance, guarantee and denial of movement, enforcement of sanctions, establishment and supervision of protected zones, forcible separation of belligerent parties, and other operations as determined by the authorizing body.

Historical Perspective

The US Army, responding to a presidential directive, participated in Operation Restore Hope in Somalia from 3 December 1992 to 4 May 1993. A joint and multinational operation, Restore Hope—called UNITAF (unified task force)—was a US-led, UN-sanctioned operation that included protection of humanitarian assistance and other peace-enforcement operations. The Army force (ARFOR) AO included over 21,000 square miles. Over these distances, units conducted air assault operations, patrols, security operations, cordons and searches, and other combat operations in support of humanitarian agencies.

Other ARFOR operations included building or rebuilding over 1,100 kilometers of roads, constructing two Bailey Bridges, escorting hundreds of convoys, confiscating thousands of weapons, and providing theater communications. Due to these efforts, humanitarian agencies declared an end to the food emergency, community elders became empowered, and marketplaces were revitalized and functioning. On 4 May 1993 the UN-led operation in Somalia (UNOSOM II) assumed responsibility for operations.

Restoration and Maintenance of Order and Stability

Military forces may be employed to restore order and stability within a state or region where competent civil authority has ceased to function. They may be called upon to assist in the maintenance of order and stability in areas where it is threatened, where the loss of order and stability threatens international stability, or where human rights are endangered.

Very often, operations to restore and maintain order and stability may be conducted in conjunction with actions designed to provide and protect the provision of humanitarian assistance.

Historical Perspective

An early example of operations in a situation of civil hostilities is found in ONUC (United Nations Operation in the Congo). When created in 1960, one of the guidelines governing ONUC was that the force was to be used only for self-defense. By February 1991, the chaotic conditions caused the security council to expand the guidelines to include directing the use of force to prevent civil war.

Protection of Humanitarian Assistance

Military forces have participated in numerous HA operations worldwide in recent years. Many HA missions may take place in benign environments. However, in other cases hostile forces may interfere with HA missions. Peace operations forces may be called upon to protect those providing such assistance or the relief supplies themselves. HA forces must be equipped with weapons systems appropriate to the mission. Such situations may require the establishment of base areas, which usually include air or sea terminals, protected routes or corridors for the transport of relief supplies, and secure sites for the final delivery of supplies to the intended recipient. If delivery of aid and relief supplies is opposed, combat and CS forces may be necessary to conduct such operations.

Guarantee and Denial of Movement

These operations guarantee or deny movement by air, land, or sea in particular areas and/or routes. They may involve the coordinated presence of warships and combat aircraft in the disputed region. Operations to guarantee rights of passage—called *freedom of navigation*—may be conducted to ensure the freedom of ships to pass through a threatened sea lane, for aircraft to reach a besieged city or community, or to maintain safe passage on overland routes. Land forces may employ a combination of infantry, armor, engineer, military police, and aviation assets to accomplish this mission.

Operations to deny movement of belligerent parties may involve the denial of air movement (air exclusion zone/no-fly zone) or overland movement to a specified area. The objective is to prevent the harassment of an unprotected population by the use of combat aircraft or to prevent the delivery of military supplies to a belligerent. Ground forces may conduct these operations by sealing a border to prevent passage.

Land forces may employ a wide range of forces to fulfill these missions, including air defense forces to deny flight. Safe operation of air defense forces will require the coordinated offensive use of electronic emissions, as well as access to strategic and tactical intelligence assessments. The joint headquarters will determine day-to-day deployment of these assets.

Historical Perspective

An example of guarantee of movement and the application of PE techniques using the principle of restraint in operations other than war (OOTW) occurred in Panama in 1989. In the wake of continuing confrontation with the Panama Defense Forces (PDF) and with the deployment of additional forces to Panama from Operation Nimrod Dancer, US forces conducted exercises called Purple Storm and later Sand Fleas. Their purpose was to enforce to the maximum the Panama Canal Treaty guaranteed rights of movement within Panama.

During these exercises, when US forces encountered interference with treaty rights to movement, the commander on the scene (a squad or platoon leader, for example) consulted a card. It authorized such actions as inserting a magazine into a weapon, fixing bayonets, cocking the weapon, issuing a warning, or opening fire. A senior military commander approved each step. At the same time, high performance aircraft flew low-level flights and armed helicopters hovered at the scene. Another technique used artillery to fire illumination or smoke rounds, demonstrating the capability to fire more lethal ammunition. In every case the PDF withdrew or ceased their offensive behavior.

Enforcement of Sanctions

Sanctions concern the denial of supplies, diplomatic and trading privileges, and freedom of movement to a sanctioned state. They are usually applied only when diplomacy and less confrontational methods of conflict resolution have failed. Used alone,

sanctions do not generally cause a government party to change its behavior. However, they can reduce a state's combat capability. To achieve a significant level of effectiveness, sanctions must be—

- Imposed with the consent of a widely based group of nations, including the unanimous support of the regional and neighboring states of the belligerent parties.
- Planned on a systematic basis, with the assistance of industrial/logistics intelligence, to withhold only the facilities (communications, commercial) or supplies that are critical to the aggressive activities of the target nation. Sanctions should not be used to victimize innocent people.
- Enforced on a regionwide cooperative basis to deny prohibited supplies and facilities to the target nation.

A military force involved in enforcing sanctions may include—

- Joint air, land, and sea warfighting capabilities.

- The presence of heavy weapons as a deterrent capability.
- A heavy reliance on air and sea interdiction.
- Execution of coordinated and uniform responses to all challenges to mandated sanctions.
- Use of electronic emissions to ensure the safety of the task force.
- A capability to sustain operations over extended periods of time.

Land forces may be required to enforce sanctions by denying overland movement of supplies to the sanctioned party. Additionally, individual soldiers may perform duties as inspectors at key transit points, ensuring that no proscribed items enter the territory of the sanctioned party. The use of force is implicit in this mission

Establishment and Supervision of Protected Zones

As part of a conflict resolution effort, protected zones may be established. These



Establishment of protected zones is part of the conflict-resolution effort.

Figure 1-2. Example of a Protected Zone

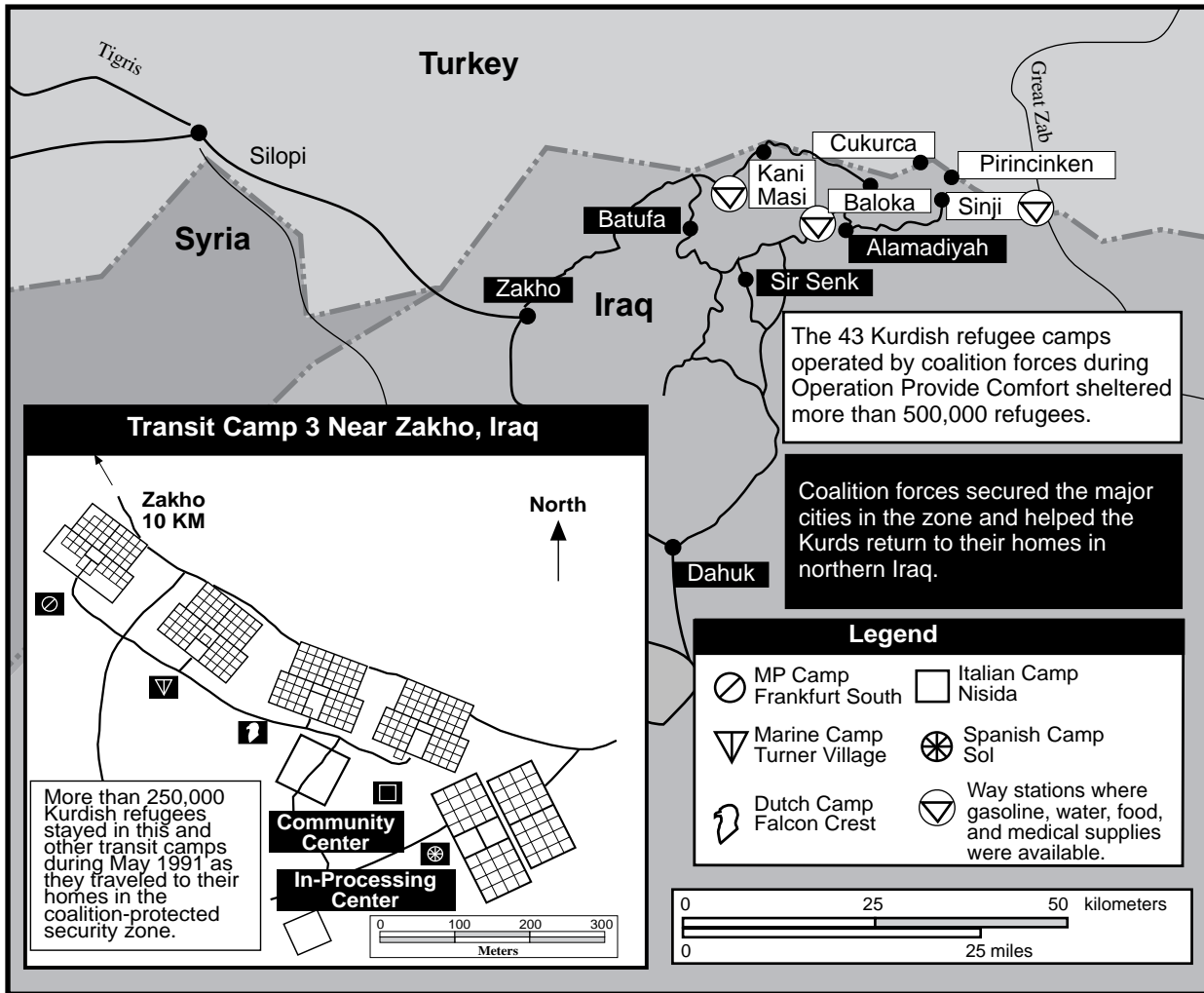

zones are geographic entities that may contain substantial numbers of forces of one or more of the belligerent parties cut off from the main body of troops. Alternatively, these zones may contain large numbers of minorities or refugees that are subject to persecution by one of the belligerent parties (see Figure 1-2).

Land forces may be charged with establishment and supervision, to include defense, of such zones. Such supervision may involve the provision of significant amounts of humanitarian assistance. The existence of these zones may be challenged by the belligerent party on whose territory they are established, as they represent a

Historical Perspective

UN action in northern Iraq following the Gulf War (1991) established protected zones for Iraq's Kurds. The zones were incidental to the provision of humanitarian assistance for the Kurds prior to turning the effort over to civil agencies (Operation Provide Comfort).

challenge to the sovereignty or control of that state or territory. Land forces must be prepared for operations by belligerent parties that threaten all or parts of the zone.

Figure 1-3. Separation of Belligerent Parties

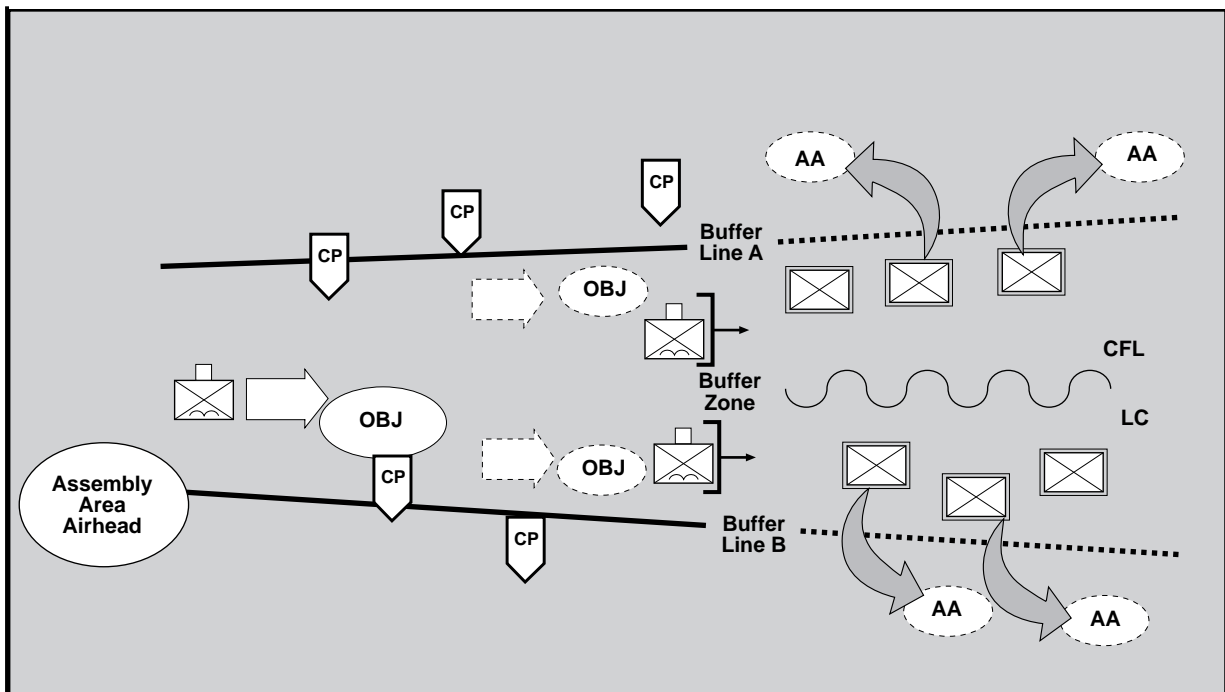

As a result, land forces suited for this mission are predominately combat and CS units. They may require a full range of organic and supporting weapons, as well as access to close air support. Since protected zones may not be contiguous to friendly territory, logistics support may be a significant challenge.

CA and PSYOP information operations may be key to the effort in establishing and sustaining the protected zones. CA units may be required to organize local governmental organizations on a temporary basis, pending resolution of the conflict.

Forcible Separation of Belligerents

It may become necessary to intervene in a conflict in order to establish the conditions necessary for peace against the will of one or more of the belligerent parties. Forcible separation of belligerent parties is the ultimate means to counter a serious threat to peace and security and should be used only when all other means of conflict resolution have been exhausted. This

activity will require the use of sufficient force, but only the minimum offensive action consistent with achieving the enforcement objective may be used. PE forces involved are likely to be multinational and joint in composition and will require an offensive capability and necessary logistics support (see Figure 1-3).

Under these circumstances, PE forces may be employed to forcibly separate the belligerent parties. This may involve reducing or eliminating the combat capability of one or more of the parties. Commanders must consider that one or more of the belligerent forces may see this as cause for aggression against the PE force.

The degree of resistance to PE operations may be proportional to the credibility of the separating force. The threat of force may serve as a powerful inducement to the engaged belligerent parties to separate. PE operations will normally require the establishment of a disengagement line or demilitarized zone. Establishment of this line or zone will require the separating force to interpose itself between belligerent parties.

The commander, in deciding on the specific course of action to forcibly separate belligerent parties, should consider—

- If sufficient forces are available.
- The antagonism between the belligerent parties.
- The lethality of the weapon systems used by the belligerent parties.
- The degree of intermingling of the civilian population with the belligerent parties.
- The content of the mandate.

When planning operations to separate belligerent parties, the commander should consider the entire range of combat operations if—

- A high degree of animosity exists between the belligerent parties and/or the PE force.
- Modern, highly lethal weapons are available.
- Low intermingling of the civilian population exists.
- The mandate has maximum flexibility.

The commander must consider that the end state is not to destroy the belligerent parties but to force their disengagement. As the commander develops the situation, he should array his forces and adjust his tempo so that the belligerent parties have an option to disengage and withdraw out of an established or emerging buffer or demilitarized zone. If they are not predisposed to withdrawal, then the only alternative is to pursue the operation vigorously to its conclusion.

DIFFERENCES BETWEEN PEACEKEEPING AND PEACE ENFORCEMENT

US policy distinguishes between PK and PE. Both are classified as peace operations. However, they are not part of a continuum allowing a unit to move freely from one to the other. A broad demarcation separates these operations. They take place under vastly different circumstances involving the variables of consent, force, and impartiality. A force tailored for PK may lack sufficient combat power for PE. Since PK and PE are different, any change must require review of the factors of mission, enemy, troops, terrain, and time available (METT-T) and force tailoring. On

the other hand, a force tailored for PE can accomplish PK missions, provided belligerent parties accept their presence. Generally, a contingent that has been conducting operations under a PE mandate should not be used in a PK role in that same mission area because the impartiality and consent divides have been crossed during the enforcement operation. Commanders must understand these key differences. The crucial discriminators between PK and PE consist of the operational variables:

Consent

In PK, belligerent parties consent to the presence and operations of PK forces, while in PE consent is not absolute and force may be used to compel or coerce. In PK, consent is clear.

Force

In PK, force may only be used in self-defense or defense with a mandate. In PE, force is used to compel or coerce.

Impartiality

In PK, impartiality is more easily maintained, while the nature of PE strains the perception of impartiality on the part of the PE force (see the following paragraph on THE VARIABLES).

THE VARIABLES

Peace operations are conducted in a dynamic environment shaped by a number of factors and variables that strongly influence the manner in which operations can be conducted. Successful commanders grasp the importance of these variables.

The critical variables of peace operations are the *level of consent*, the *level of force*, and the *degree of impartiality*. The degree to which these three variables are present plays a major role in determining the nature of the peace operation and force-tailoring mix. They are not constant and may individually or collectively shift during the course of an operation.

Commanders who are aware of these variables and the direction in which they tend to move may be more successful in influencing

them and thereby controlling the operational setting. In order to exercise control, they must be able to influence the variables and the pace and direction of change. Success in peace operations often hinges on the ability to exercise situational dominance with respect to the variables; failure is often the result of losing control of one or more of them. Commanders must avoid inadvertently slipping from one type of peace operation to another. Figure 1-4 shows expected levels of consent, force, and impartiality during the different types of operations. Assessments of the level of consent are political-military in nature and possibly policy driven. Such assessments are factors in determining force tailoring for operations.

LEVEL OF CONSENT

In war, consent is not an issue of concern for the military commander. In peace operations, however, the level of consent determines fundamentals of the operation. One side may consent in whole or in part, multiple parties may consent, there may be no consent, or the consent may vary dramatically over time.

In a traditional PK operation, loss of consent may lead to an uncontrolled escalation of violence and profoundly change the nature of the operation. Any decline of consent is therefore of significant concern to the peace operation commander and may unfavorably influence the subsequent development of the campaign. The crossing of the *consent divide* from PK to PE is a policy level decision that fundamentally changes the nature of the operation. Commanders should avoid hasty or ill-conceived actions that unintentionally cause a degradation of the level and extent of consent.

LEVEL OF FORCE

Peace operations cover a broad range of military operations. While traditional PK is generally nonviolent, PE may include very violent combat actions. The need to employ force may begin a cycle of increasing violence; therefore, commanders must be judicious in employing forceful measures and must understand the relationship between force and the desired end state. Of the three variables, the level of force is usually the only one over which the commander can exert dominant influence. Operational level commanders or higher authorities will usually decide about the use of force in this context (other than self-defense).

DEGREE OF IMPARTIALITY

A peace operation is likewise influenced by the degree to which the force acts in an impartial manner and the degree to which the belligerent parties perceive the force to be impartial. PK requires an impartial, even-handed approach. PE also involves impartiality, which may change over time and with the nature of operations. An even-handed and humanitarian approach to all sides of the conflict can improve the prospects for lasting peace and security, even when combat operations are underway. Compromised impartiality may trigger an uncontrollable escalation from a PK to a PE situation by crossing the consent divide.

In circumstances where the required degree of impartiality is unclear, the commander must press the authorizing body for clarity since misunderstanding can be disastrous. A basic understanding of PK missions is essential to

Figure 1-4. Operational Variables

Variables	Support to Diplomacy	Peacekeeping	Peace Enforcement
Consent	High	High	Low
Force	Low	Low (self-defense/defense of mandate from interference)	Sufficient to compel/coerce
Impartiality	High	High	Low

differentiate PK from PE missions. PK enjoys high levels of consent and impartiality and low levels of force (generally only in self-defense), while PE is marked by the reverse. Regardless of the type of operations, commanders should always strive to increase levels of consent and impartiality and reduce the levels of force.

ADDITIONAL CONSIDERATIONS

Other factors may include—

- The geopolitical situation.
- Prevailing social conditions and cultures.
- The scale of conflict or effectiveness of a cease-fire.
- The number, discipline, and accountability of contending parties.
- The efficacy of local government.
- The degree to which law and order exists.
- The prevailing attitude and willingness of the population at large to cooperate.

In peace operations, national and international news media coverage plays a major role in quickly framing public debate and shaping public opinion. The news media serves as a forum for the analysis and critique of goals, objectives, and actions. It can impact political, strategic, and operational planning; decisions; and mission success and failure. Therefore, commanders should involve themselves in information operations.

Humanitarian assistance is not included in the definition of peace operations; however HA programs will probably be conducted simultaneously in almost every peace operation. Normally limited in their scope and duration, HA projects have a significant impact on resources required and other aspects of peace operations. HA programs will often take place following PE. HA includes programs conducted to relieve or reduce the results of complex emergencies involving natural or man-made disasters or other endemic conditions such as human pain, disease, hunger, or privation that might present a serious threat to life or that may result in great damage or loss of property. HA supplements or complement the efforts of a host nation, civil authorities, or agencies that may have primary responsibility for HA.

HA are normally be conducted by a joint task force and in concert with nongovernment organizations (NGOs) and private voluntary organizations (PVOs). Depending on the situation, it may be necessary to stage HA operations from a third country or from the sea. Normally, it is necessary to establish a base of operations in the AO that includes both CS and CSS units and Army Materiel Command (AMC) logistics support element (LSE) units. Special operations units such as Special Forces operational detachments-A (SFODAs) and civil affairs direct support teams (CADSTs) may also play a key role, particularly in the provision of medical and sanitation assistance. They may also assist in communicating with local populations and assisting logistics elements in securing support. HA tasks include—

- Distribution of relief supplies.
- Transportation of relief supplies and civilians.
- Provision of health services.
- Provision of essential services.
- Resettlement of dislocated civilians.
- Disposition of human remains.
- Establishment of essential facilities.

Units conducting HA actions deploy with weapons. In a permissive environment, soldiers carry an assigned weapon for self-defense. Deployed civilians may carry a weapon, if authorized and trained.

Private organizations that provide HA should be included in a commander's assessment of a peace operation. They generally fall into one of three categories: NGOs, PVOs, and UN organizations. Appendix B lists examples of such organizations. NGOs and PVOs may be professional associations, foundations, multinational businesses, or simply groups with a common interest in HA activities (development and relief).

NGOs, PVOs, and UN organizations play an important role in providing HA and support to host nations. They can relieve a commander of the need to resource some civil-military operations. Because of the extent of their involvement or experience in various nations and because of

their local contacts, these organizations may be a valuable source of information on local and regional governments, civilian attitudes toward the peace operation, and local support or labor. However, some organizations may prefer to avoid a close affiliation with military forces for fear of compromising their position with the local populace.

On occasion, the US Agency for International Development (USAID) and other relief organizations provide funding for civil engineering infrastructure projects. NGOs and PVOs have the ability to respond quickly and effectively to disaster relief, food distribution needs, and programs aimed at addressing the root causes of poverty and vulnerability to disaster. While continuing to be responsive to immediate human needs, particularly in emergency situations, NGOs and PVOs increasingly contribute to long-term development activities crucial to improving conditions in the developing world.

In addition to HA, the US has supported numerous UN and non-UN-sponsored peace efforts with *financial* and *logistical support*. Financial support is often the principal form of US support to international peace operations, especially UN-sponsored peace operations. Although participating countries may fund the operation in certain cases, the UN, through the contributions of its members, funds the costs in others.

The US may also provide logistics support in the form of equipment and supplies, as well as by providing airlift and sealift for US and other peace operations contingents. The United States is one of the few nations capable of providing the intertheater airlift and sealift necessary to deploy and redeploy peace operations forces around the world. Additionally, *The United Nations Participation Act of 1945*² authorizes the President to provide reimbursable logistics support to UN forces.

THE PRINCIPLES

The principles of OOTW, as outlined in FM 100-5, apply to the conduct of peace operations. Although peace operations are clearly OOTW, many tasks at the tactical and operational levels may require the focused and sus-

tained application of force. This is particularly true of PE actions. Thus, while the principles of OOTW provide guidance for the conduct of the great majority of peace operations, the principles of war and doctrine for conduct of war in FM 100-5 must be included in the planning process for all peace operations. The principles of peace operations follow.

OBJECTIVE

Direct every military operation toward a clearly defined, decisive, and attainable objective.

A clearly defined and attainable objective—with a precise understanding of what constitutes success—is critical when the US is involved in peace operations. Military commanders should understand specific conditions that could result in mission failure as well as those that mark success. Commanders must understand the strategic aims, set appropriate objectives, and ensure these aims and objectives contribute to unity of effort with other agencies.

The Mandate and Terms of Reference

In peace operations, a mandate normally sets forth an objective and is a resolution approved by a competent authorizing entity such as the UN Security Council or the US Government in the case of unilateral actions. In any case, the resolution and follow-on terms of reference (TOR) delineate the role and tasks for the force as well as the resources to be used. See Annexes A and B to Appendix A.

The mandate should express the political objective and international support for the operation and define the desired end state. Military commanders with unclear mandates should take the initiative to redefine, refine, or restate the mandate for consideration by higher authority. The following considerations are of concern to commanders in regard to the mandate and the follow-on TOR for the operation:

- Rules of engagement (ROE).
- Force protection.
- Limitations of a geographical nature.
- Limitations on the duration of the operation.
- Relationships with belligerent parties.

² Public Law 79-264 as amended.

- Relationships with others such as NGOs or PVOs.
- Financing and personnel resources.

The End State

The end state describes the required conditions that, when achieved, attain the strategic and political objectives or pass the main effort to other national or international agencies to achieve the final strategic end state. The end state describes what the authorizing entity desires the situation to be when operations conclude.

Since peace operations are intended to create or support conditions conducive to a negotiated conflict resolution, they always complement diplomatic, economic, informational, or humanitarian efforts. The peace operation should not be viewed as an end in itself, but as part of a larger process that must take place concurrently.

UNITY OF EFFORT

Seek unity of effort in every operation.

This principle is derived from the principle of war, *unity of command*. US forces will retain unity of command within their contingents. Unity of effort emphasizes the need for directing all means to a common purpose. However, in peace operations, achieving unity of effort is complicated by the numbers of nonmilitary organizational participants (including NGOs and PVOs), the lack of definitive command arrangements among them, and varying views of the objective. These factors require that commanders, or other designated directors of the operation, rely heavily on consensus-building to achieve unity of effort.

Commanders may answer to a civilian chief or may themselves employ the resources of a civilian agency. Fundamental to the successful execution of the peace operation is the timely and effective coordination of the efforts of all agencies involved. Commanders must seek an atmosphere of cooperation to achieve unity of effort.

Whenever possible, commanders should seek to establish a control structure, such as a civil-military operations center, that takes

account of and provides coherence to the activities of all elements in the area. As well as military operations, this structure should include the political, civil, administrative, legal, and humanitarian activities involved in the peace operation. Without such a structure, military commanders need to consider how their actions contribute to initiatives that are also diplomatic, economic, and informational. This requirement necessitates extensive liaison with all involved parties, as well as reliable communications. Because peace operations often involve small-unit activities, to avoid friction, all levels must understand the military-civilian relationship.

A single, identifiable authority competent to legitimize and support a peace operation, both politically and materially, is essential. The appointment of an individual or agency to execute the policies of the parties to an agreement results in more effective control of an operation. Such control is exercised at the interface point between the operational structure and the body that authorizes the operation and appoints the authority. This characteristic is related to and serves to reinforce the principle of unity of effort.

In many cases the legitimizing authority for PK is the UN, although other international organizations may assume this role. In such instances, the UN or other body is the competent authority and ensures single-manager control. This authority may be delegated or subcontracted to a subordinate body. In some non-UN operations, a state or coalition of states may be the competent authority.

SECURITY

Never permit hostile factions to acquire an unexpected advantage.

In peace operations, security deals with force protection as a dynamic of combat power against virtually any person, element, or hostile group. These could include terrorists, a group opposed to the operation, criminals, and even looters.

Commanders should be constantly ready to prevent, preempt, or counter activity that could bring significant harm to units or jeopardize mission accomplishment. In peace operations, commanders should not be lulled into believing that the nonhostile intent of their mission protects

their force. The inherent right of self-defense, from unit to individual level, applies in all peace operations at all times.

Security, however, requires more than physical protective measures. A force's security is significantly enhanced by its perceived legitimacy and impartiality, the mutual respect built between the force and the other parties involved in the peace operation, and the force's credibility in the international arena. Effective public affairs, PSYOP, and CA programs enhance security. In PE, security involves demonstrations of inherent military capability and preparedness. Sustainment training, as well as the overt presence of uncommitted mobile combat power available as a reserve, may also enhance security.

In a peace operation security and force protection may extend beyond the commander's forces to civil agencies and NGOs. Additionally, the transparency required for peace operations may preclude the use of some force-protection techniques such as camouflage.

RESTRAINT

Apply appropriate military capability prudently.

Restraints on weaponry, tactics, and levels of violence characterize the environment of peace operations. The use of excessive force may adversely affect efforts to gain or maintain legitimacy and impede the attainment of both short- and long-term goals. These restraints should be clearly spelled out in the ROE provided for the operation by higher authority.

In PK, force is used only in self-defense or defense of the mandate from interference. In PE, force may be used to coerce. It may have far-reaching international political consequences. The use of force may attract a response in kind. Its use may also escalate tension and violence in the local area and embroil peace operations troops in a harmful, long-term conflict contrary to their aims. For that reason, the use of force should be a last resort and, whenever possible, should be used when other means of persuasion are exhausted.

Commanders should always seek to de-escalate and not inflame an incident or crisis whenever possible. Alternatives to force should be fully explored before armed action is taken. They

include mediation and negotiation, which may be used to reconcile opponents, both to one another and the peace operation force.

In many societies, self-esteem and group honor are of great importance and simple face-saving measures to preserve a party's dignity may serve to relax tension and defuse a crisis. Other alternatives to the use of force include deterrence; control measures, such as pre-planned or improvised roadblocks, cordons, and checkpoints; warnings; and demonstrations or shows of force. As a rule—to limit escalation—conciliatory, deterrent, controlling, and warning actions should be carried out on the spot and at the lowest possible level.

In PE, force must be employed with restraint appropriate to the situation. In PE operations, the use of force is the primary characteristic that determines the nature of the operation, and authority for its use should be clear and unambiguous in the mandate. In all cases, force will be prudently applied proportional to the threat. In peace operations, every soldier must be aware that the goal is to produce conditions that are conducive to peace and not to the destruction of an enemy. The enemy is the conflict, although at times such operations assume the character of more traditional combat operations. The unrestrained use of force will prejudice subsequent efforts at achieving settlement.

This principle does not preclude the application of sufficient or overwhelming force when required to establish situational dominance, to display US resolve and commitment, to protect US or indigenous lives and property, or to accomplish other critical objectives. The principle of restraint will permeate considerations concerning ROE, the choice of weapons and equipment, and control measures such as weapons control status. When force is used, it should be precise and overwhelming to minimize friendly and noncombatant casualties and collateral damage. Precision and high-technology weaponry may help reduce casualties.

PERSEVERANCE

Prepare for the measured, sustained application of military capability in support of strategic aims.

While some peace operations may be of short duration, most require long-term commitments that involve more than military efforts alone. Underlying causes of confrontation and conflict rarely have a clear beginning or a decisive resolution. Commanders need to assess actions against their contribution to long-term, strategic objectives.

Perseverance requires an information strategy that clearly explains the goals, objectives, and desired end states and links them with US interests and concerns. The long-term nature of many peace operations must be continually emphasized, without giving the impression of permanency.

LEGITIMACY

Sustain the willing acceptance by the people of the right of the government to govern or a group or agency to make and carry out decisions.

Legitimacy is a condition growing from the perception of a specific audience of the legality, morality, and correctness of a set of actions. It is initially derived from the mandate authorizing and directing the conduct of operations. However, the perception of legitimacy can only be sustained with the US public, US forces, indigenous parties, and the international community if operations are conducted with scrupulous regard for international norms on the use of military forces and regard for humanitarian principles. Commanders must be aware of the authority under which they operate and the relationship between it and the other sources of legitimacy that are present. During operations where a clearly legitimate government does not exist, using extreme caution in dealing with individuals and organizations will avoid inadvertently legitimizing them. The conduct of information operations, to include public affairs, CA, and PSYOP programs, can enhance both domestic and international perceptions of the legitimacy of an operation.

In PK operations, the impartiality of peacekeepers and the sponsoring state, states, or international organization is critical to success and the legitimacy of the operation. It must be demonstrated at all times, in all dealings, and under all circumstances, whether operational, social, or administrative. All activities must be conducted

without favor to either side or point of view. Because of the nature of PE operations, impartiality and legitimacy may be harder to obtain and sustain. Legitimacy also reinforces the morale and esprit of the peace operations force.

Historical Perspective

Of 22 UN PK operations conducted between 1947 and 1991, about one-fourth derived from the UN Security Council. An example is UNTSO, which was established in 1948 as a result of the conflict in the Middle East. Another one-fourth were requested by belligerent parties in a local conflict, for example, the UN Military Observer Group in India and Pakistan established in 1948 at the request of India because of the Kashmir dispute. The remaining operations resulted from brokered requests by third parties who asked for UN help, for example, when the US mediated the UN Disengagement Observer Force, which was established in 1974 as a result of the October War.

Legitimacy is in some cases also a function of balance. Balance refers to the geographic, political, and functional makeup or composition of the peace operations force. Balance is a function of consent and operational need. In PK operations, the belligerent parties may insist that the force contain elements from countries that are mutually acceptable and geopolitically balanced in terms of regional or political affiliation. In PE operations, balance may be a less critical consideration.

THE TENETS

The tenets of Army operations, as described in FM 100-5, apply to peace operations as well. These basic truths held by the Army describe the successful characteristics of peace operations and are fundamental to success.

VERSATILITY

Versatility is an essential quality of peace operations. Commanders must be able to shift focus, tailor forces, and move rapidly and effectively from one role or mission to another. However, versatility does not imply an inadvertent shifting of missions between PK and PE. Versatility implies the capacity to be multifunctional. Versatility requires competence in a variety of functions and skills. It ensures that units are capable of conducting the full range of peace operations with the same degree of success.

INITIATIVE

In peace operations, initiative implies that the peace operations force controls events rather than letting the environment control events. Commanders must ensure that the belligerent parties do not exercise control over the flow of events to the detriment of one or the other. Within the limits of the mandate, commanders must further the process of conciliation. Commanders must anticipate belligerent actions and use the means available to forestall, preempt, or negate acts that do not further the process. In PE, commanders may gain initiative by possessing a combined arms force that demonstrates its full range of capabilities without directly challenging any one party to the conflict.

AGILITY

In peace operations, agility is the ability to react faster than other parties and is essential for holding the initiative. As commanders perceive changes to their environment, they devise imaginative methods of applying their resources to those changes and act quickly to gain control of the events. For example, in PK, Army forces

might attempt to defuse conditions that could otherwise lead to a resumption of fighting by recognizing the inherent dangers and by resolving grievances before they ignite into open combat. A situational awareness that perceives and anticipates changes in the environment, combined with the ability to act quickly within the intent of higher commanders, leads to an agility in peace operations that is vital to successful outcomes. Rehearsals will enhance agility.

DEPTH

Depth extends peace operations activities in time, space, resources, and purpose to affect the environment and the conditions to be resolved. In their campaign planning, commanders envision simultaneous activities and sequential stages that lead to solutions. PK may begin with an initial objective of observing a cease-fire, move to postconflict activities such as peace building, and involve many resources—not only military but also diplomatic, humanitarian, and informational.

SYNCHRONIZATION

Synchronization implies the maximum use of every resource to make the greatest contribution to success. In peace operations, the many players involved and increased emphasis on use of CA and PSYOP assets will be important considerations. To achieve this requires the anticipation that comes from thinking in depth, mastery of time-space-purpose relationships, and a complete understanding of the ways in which the belligerent parties in a peace operation interact. Commanders must understand how all parties will view their actions. Synchronization is essential to sustaining legitimacy by maintaining the perception of impartiality.

CHAPTER 2

Command, Control, Coordination, and Liaison

Consensus will be important

Teamwork and trust are essential.

FM 100-5

US military forces conducting peace operations may do so as part of a unilateral US operation or as part of a multinational force led by the US or another nation. This chapter discusses the various command, control, coordination, and liaison requirements for forces conducting peace operations. The command arrangements of US forces committed to a unilateral or multinational peace operation vary with the type of operation (Figure 2-1), the level of US involvement, and the nature of the international organization charged with the operation. FM 100-8¹ provides details on the various command arrangements that apply to peace operations for forces under national control, dual control, or with a lead nation command structure. The latter is further depicted with national or multinational subordinate formations, allied subordinate formations, or integrated formations. In most instances, elements will operate as part of a joint force. Joint Publication 3-0² fully addresses the command relationships for such operations. Other agencies, both government and nongovernment, invariably participate in these operations as well. This chapter addresses coordination and cooperation with such agencies

¹. Multinational Operations.

². *Doctrine for Joint Operations*, 9 September 1993.

Figure 2-1. Types of Command Arrangements

Unilateral US operation	<ul style="list-style-type: none">• US acts alone• Responds only to NCA
Multinational operation US as lead nation	<ul style="list-style-type: none">• US leads operation• Mandate from international organization• Reports to organization and US NCA
Multinational operation US in support	<ul style="list-style-type: none">• US is not lead nation• US contribution may be combat or logistics• Mandate from international organization• US reports to organization and US NCA

COMMAND AND SUPPORT RELATIONSHIPS

Command is central to all military actions, and unity of command is central to unity of effort. A common understanding of command relationships will facilitate the required unity of effort. Various multinational directives which delineate the degree of authority that may be exercised by a multinational commander and procedures that ensure unity of effort will set forth command relationships. These procedures should include provisions regarding if, when, and how the transfer of authority from national command to multinational command may take place. The authority vested in a commander must be commensurate with the responsibility assigned. Ideally, the coalition or alliance will designate a single military commander to direct the multinational efforts of the participating forces. Command and support relationships will likely include terms similar to those used in US joint relationships, for example, *operational control (OPCON)*, *tactical control (TACON)*, *support*, *coordinating authority*, or terms that identify a similar type of authority such as *operational command (OPCOM)* or *tactical command (TACOM)*. These terms, including NATO terms, are defined in the glossary.

UNILATERAL OPERATIONS

Even though most peace operations have been conducted by a coalition of forces, the US reserves the right to conduct a peace operation unilaterally, as it did in Lebanon in 1958. Frequently, a peace operation that begins unilaterally may transition to a coalition operation. The US operation to provide and protect humanitarian assistance in Somalia began in 1992 as a US-only operation and transitioned to a US-led coalition and, later, UN-led operation. Because the US possesses the unique capability to rapidly deploy by strategic lift, it may find itself initially forced to conduct peace operations unilaterally until a coalition can be assembled.

MULTINATIONAL OPERATIONS

The US has tried to avoid purely unilateral operations. The operation in the Dominican Republic in 1965 (Figure 2-2), for example, was

under the aegis of the Organization of American States (OAS). More recently, Operation Provide Comfort included a coalition of forces from other nations under the sponsorship of the UN. US forces may participate in a US-led coalition such as Operation Restore Hope (Somalia) or a non-US led coalition such as Operation Able Sentry (FYROM) (Figure 2-3). In either case, US forces will be committed to execute mandates sponsored by the UN or other international or regional organizations such as OAS or the North Atlantic Treaty Organization (NATO). These operations may be divided into two categories—UN- or non-UN-sponsored.

The effectiveness of multinational operations will be improved by—

- Establishing rapport and harmony among senior multinational commanders. Only commanders can develop such a personal, direct relationship. The keys are respect, trust, and the ability to compromise. The result will be successful teamwork and unity of effort.
- Respecting multinational partners and their ideas, culture, religion, and customs. Such respect (consideration and acceptance) shows each partner's importance to the alliance or coalition.

Historical Perspective

In 1900, the US Army participated in the first multinational operation since the Revolutionary War in the Boxer Rebellion in China. In Peking, foreign legations from several nations were besieged by members of the secret anti-foreign society known as the Righteous, Harmonious Fists—the Boxers. British Admiral E.H. Seymour headed a coalition of British, German, Russian, French, American, Japanese, Italian, and Austrian forces to rescue the foreign legations. The US contingent commanded by MG Adna R. Chaffee was composed of two infantry regiments, a cavalry regiment, a Marine battalion, and a field artillery battery. A multinational force eventually forced the Boxers out of Peking.

Figure 2-2. US and OAS Relationships

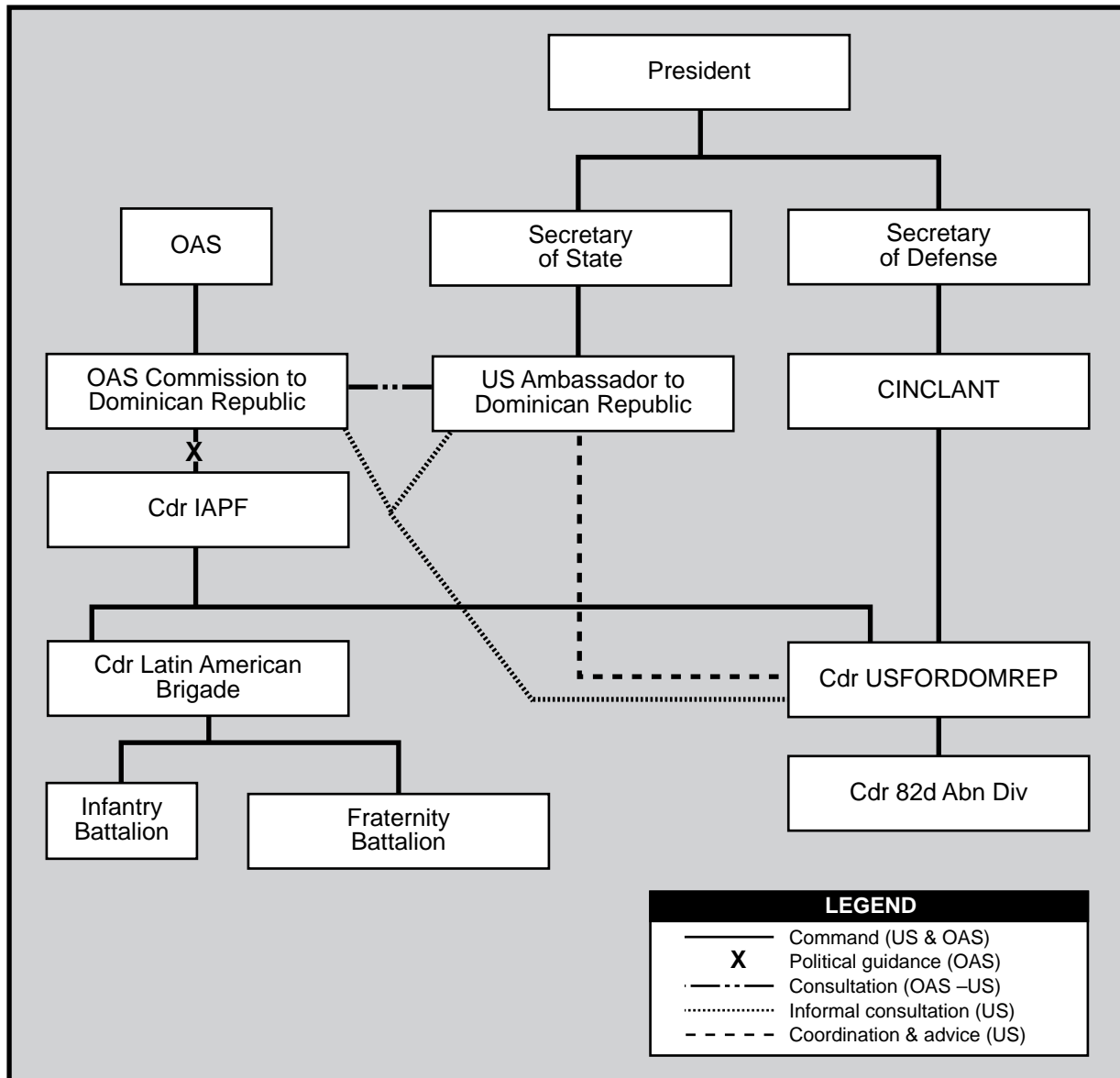

- Assigning missions appropriate to each multinational partner's capabilities. Multinational partners' opinions should be sought during the planning process. National honor and prestige may significantly impact mission assignment.
- Ensuring that multinational partners have necessary resources to accomplish their assigned missions. Cross-leveling among partners may be required.
- Ensuring concerted action through liaison centers. The ability to communicate in a partner's native language is important because it enhances and facilitates liaison.
- Enabling all partners to operate together in the most effective manner and to make the most efficient and economical use of resources. Standardization agreements are the result of rationalization, standardization, interoperability (RSI) efforts in alliances. These agreements may be appropriate for rapid adoption by coalitions.

Figure 2-3. Command Structure for Operation Able Sentry

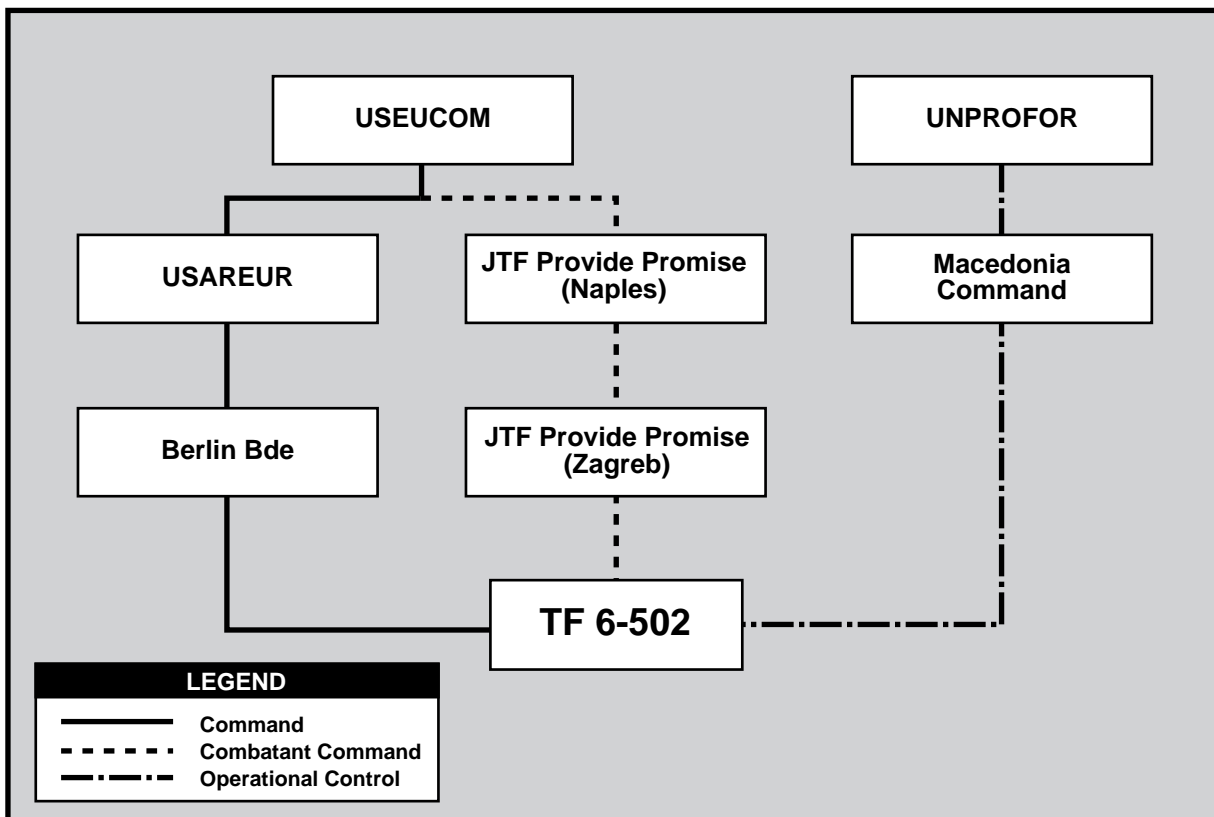

- Ensuring all multinational members' efforts are focused on a common goal to produce unity of effort.
- Knowing and understanding the capabilities of multinational partners as well as or better than you know the belligerent parties—from movement and maneuver to logistical support.

UNITED NATIONS OPERATIONS

The great majority of US peace operations will be part of a UN peace operation. Their multinational character merits particular attention. National interests and organizational influence may compete with doctrine and efficiency. Consensus is painstakingly difficult, and solutions are often national in character. Commanders can expect contributing nations to adhere to national policies and priorities, which at times complicates the multinational effort.

United Nations-sponsored operations normally employ a force under a single commander. The force commander is appointed by the secretary general (SYG) with the consent of the UN Security Council. The force commander reports either to a special representative of the SYG or directly to the SYG. While the force commander conducts day-to-day operations with fairly wide discretionary powers, he refers all policy matters to the special representative or SYG for resolution.

The force commander's staff will be multinational. Its national membership may sometimes be based on the percentage of troops on the ground. It is normally composed of a personal staff, a military staff, and a civilian component. The composition and functions of the personal and military staff correspond closely to those found in US forces. The international civilian staff is augmented with local civilians hired to provide basic logistics and administrative skills.



Multinational operations are divided into two categories--Un- and non-UN-sponsored.

In any multinational operation, the US commander retains command over all assigned US forces. The US chain of command runs from the National Command Authorities (NCA) to the theater CINC. The chain of command, from the President to the lowest US commander in the field, remains inviolate. Subject to prior NCA approval, a multinational force commander may exercise appropriate and negotiated OPCON over US units in specific operations authorized by a legitimizing authority such as the UN Security Council in UN operations. In addition to these control considerations, support relationships and arrangements may often be more appropriate to peace operations.

The degree of OPCON exercised over US units must be coordinated and agreed to between the superior multinational force commander and the US theater CINC who provides the US forces subordinate to the multinational force. This agreement must be in consonance with the NCA criteria for peace operations command and control arrangements. These criteria establish limits to the

OPCON that may be exercised over US units. Within these limits, a foreign UN commander cannot—

- Change the mission or deploy US forces outside the area of responsibility agreed to by the NCA.
- Separate units, redirect logistics and supplies, administer discipline, promote individuals, or modify the internal organization of US units.

Arrangements for support in these operations may vary from one nation being responsible for all logistics and support, to various participating nations being responsible for particular aspects of an entire operation, to the sponsoring authority providing equipment and supplies. Logistics responsibilities are normally negotiated at the time of force formation and should reflect an appreciation of various national capabilities as well as proportionality. Simplicity is an important asset to consider in all peace

operations. Facility requirements should be minimized to avoid any perception of permanency but be consistent with the anticipated duration of operations and the health and welfare of the troops.

A national contingent consists of a nation's entire contribution—its units as well as its staff

officers in the force headquarters. National contingent commanders report directly to the force commander. *National contingent commanders act in an advisory capacity to the UN force commander and his staff on contingent matters.*

Each unit commander is ultimately responsible for accomplishing his mission, is responsible to the force commander, and is responsible to his national chain of command. US units normally maintain a direct line of communications to an appropriate US headquarters—normally the theater combatant commander. Other participants in a coalition can be expected to maintain similar lines of communication (see Figure 2-4).

The national contingent commanders are responsible for disciplinary action within their own contingents and according to their national codes of military law. Authority for national contingent commanders to carry out their national laws in the host nation's territory should be included in the agreement for the peace operation. When US military unit commanders cannot resolve a matter with the UN commander, they will refer the matter to a higher US authority. Such matters include orders that are illegal

Historical Perspective

US forces have served under temporary OPCON of foreign commanders in operations during the Revolutionary War, the Boxer Rebellion, World War I, World War II, the Cold War (NATO), and Operation Desert Storm and in UN operations since 1948. In Operation Desert Storm, a US brigade from the 82d Airborne Division was placed under OPCON of the French 6th Light Armored Division. Their mission was to screen the western flank of coalition operations.

Figure 2-4. Generic Multinational Command Structure

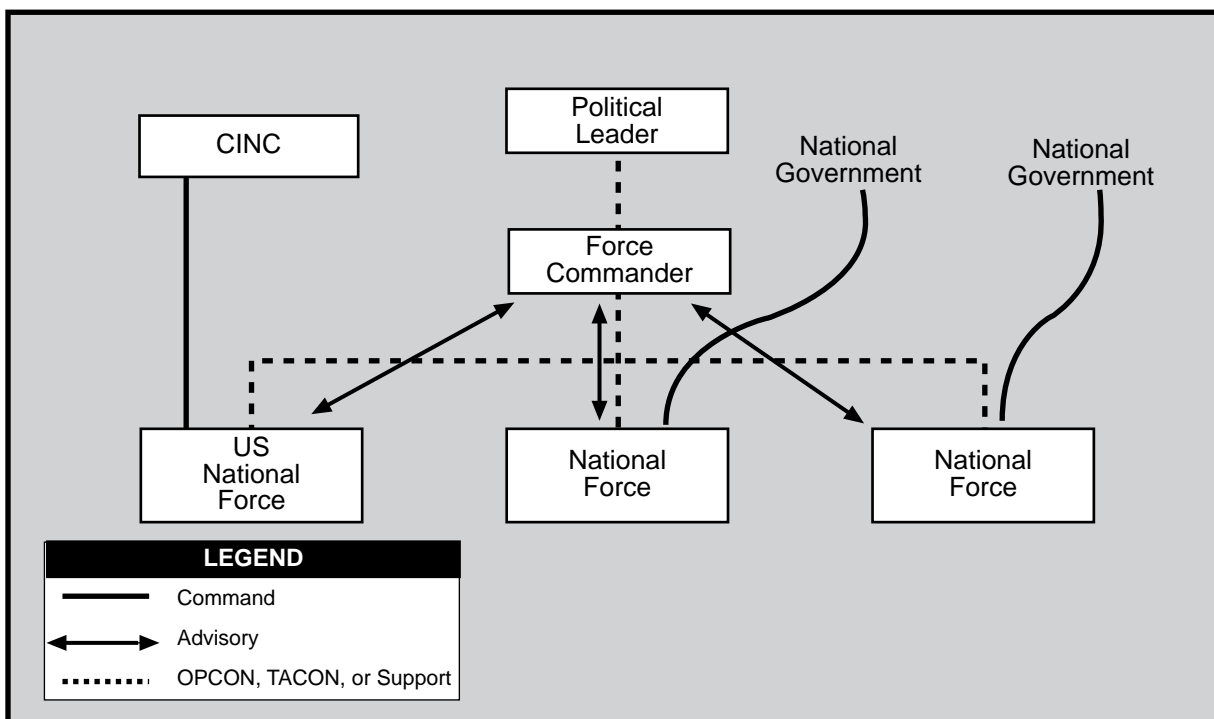

under US or international law or are outside the mandate of the mission to which the US agreed with the UN. They also include guidance and constraints placed on US commanders by the US CINC. See Appendix A for further details on UN operations.

Extract of General Principles ³
Chapter X - Strategic Direction and Command of Armed Forces

Article 39

The command of national contingents will be exercised by commanders appointed by the respective member nations. These contingents will retain their national character and will be subject at all times to the discipline and regulations in force in their own national armed forces.

Article 40

The commanders of national contingents will be entitled to communicate directly with the authorities of their own country on all matters.

NON-UNITED NATIONS OPERATIONS

While the UN is the organization most likely to undertake peace operations, a number of regional organizations may perform this function or the UN may designate a specific organization as its operational agent. Organizations such as NATO, the Organization of African Unity, the OAS, and Conference on Security and Cooperation in Europe (CSCE) have performed a variety of functions related to peace operations, to include monitoring of elections. They also execute peace operations within their areas of interest.

Each of these organizations will have different operational concepts and organizational pro-

3. Extracted from *General Principles Governing the Organization of Armed Forces* made available to the Security Council by member nations of the UN: Report of the Military Staff Committee, 30 April 1947

cedures. In the case of NATO, these concepts and procedures are well-established and US forces are accustomed to operating within those guidelines. In the case of other international organizations, these guidelines may not be as well established or may be nonexistent. Operations conducted under the aegis of such organizations will necessarily be more ad hoc in nature. In each of these operations the precise nature of the command relationship between the US forces and the international organization is subject to mutual resolution.

HUMANITARIAN ASSISTANCE

Commanders must consider the presence and capabilities of NGOs and PVOs and coordinate and cooperate with their efforts. Commanders can establish a CMOC. The CMOC may perform liaison and coordination between the



Humanitarian assistance should be directed toward the relief of immediate, life-threatening suffering.

Figure 2-5. Civil-Military Operations Center

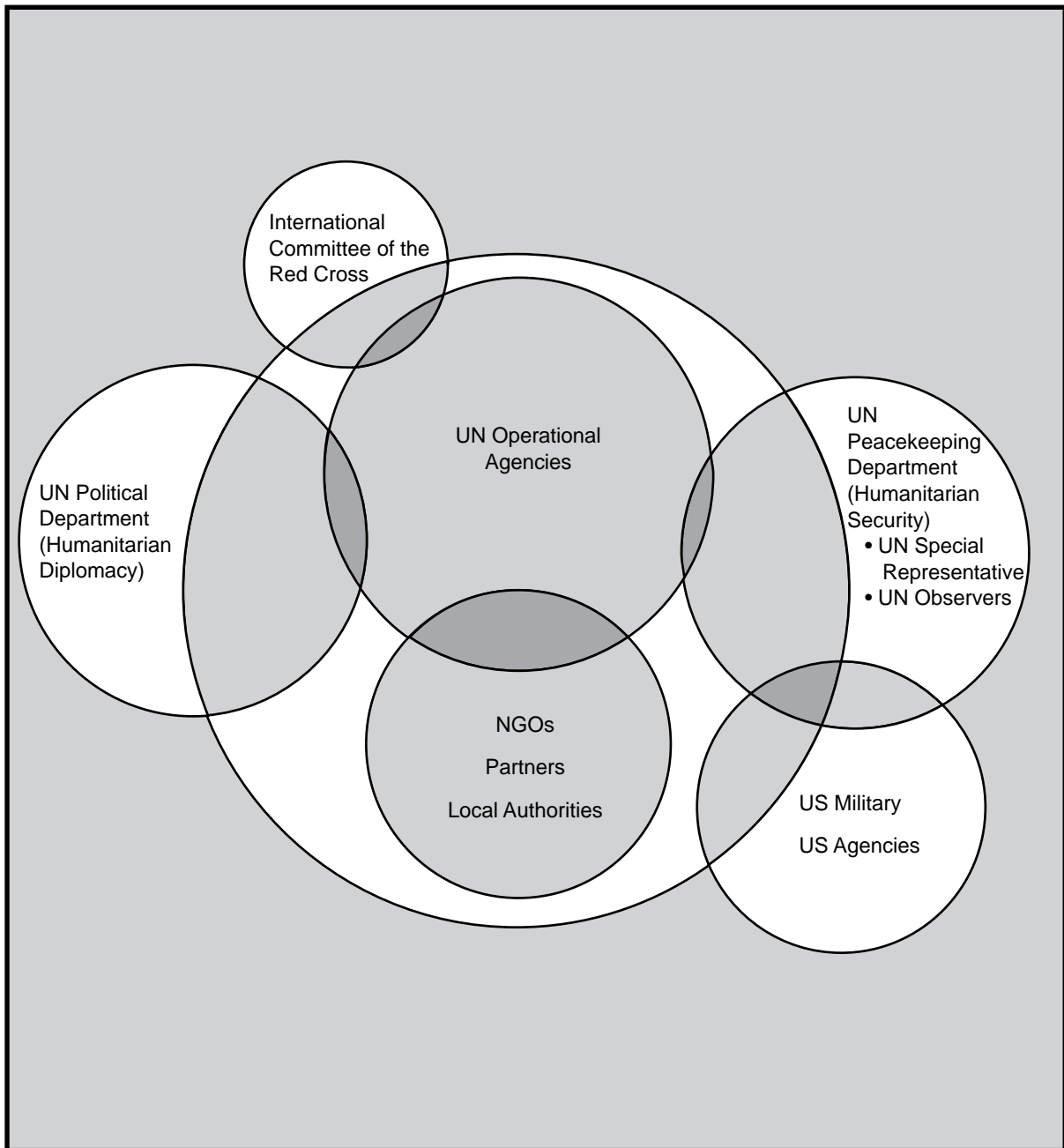

military support structure, NGOs and PVOs, other agencies, and local authorities. Figure 2-5 illustrates players that may interact with a CMOC. Commanders must understand that NGOs and PVOs have valid missions and concerns, which at times may complicate the mission of US forces. Relationships with nonmilitary

agencies are based on mutual respect, communication, and standardization of support. Such organizations are to be supported where feasible in compliance with the mandate and military objective (see Appendix B for further discussion of related organizations).

The Humanitarianism and War Project of the Thomas J. Watson, Jr. Institute for International Studies at Brown University, developed a set of eight principles that figure prominently in deliberations by practitioners of humanitarian assistance. Commanders should be aware of the possibility of specific dilemmas and tensions as they conduct peace operations in support of HA.

PRINCIPLES OF HUMANITARIAN ACTION IN ARMED CONFLICT¹

1. **Relieving Life-Threatening Suffering:** Humanitarian action should be directed toward the relief of immediate, life-threatening suffering.
2. **Proportionality to Need:** Humanitarian action should correspond to the degree of suffering, wherever it occurs. It should affirm the view that life is as precious in one part of the globe as another.
3. **Nonpartisanship:** Humanitarian action responds to human suffering because people are in need, not to advance political, sectarian, or other agendas. It should not take sides in conflicts.
4. **Independence:** In order to fulfill their mission, humanitarian organizations should be free of interference from home or host political authorities. Humanitarian space is essential for effective action.
5. **Accountability:** Humanitarian organizations should report fully on their activities to sponsors and beneficiaries. Humanitarianism should be transparent.
6. **Appropriateness:** Humanitarian action should be tailored to local circumstances and aim to enhance, not supplant, locally available resources.
7. **Contextualization:** Effective humanitarian action should encompass a comprehensive view of overall needs and of the impact of interventions. Encouraging respect for human rights and addressing the underlying causes of conflicts are essential elements.
8. **Subsidiary of Sovereignty:** Where humanitarianism and sovereignty clash, sovereignty should defer to the relief of life-threatening suffering.

¹ Quoted by permission of Larry Minear and Thomas G. Weiss, co-directors, Humanitarian and War Project, from *Humanitarian Actions in Times of War*. Other widely recognized documents have elaborated humanitarian principles. See, for example, "The Mohonk Criteria for Humanitarian Assistance in Complex Emergencies," produced by the Task Force on Ethical and Legal Issues in Humanitarian Assistance, convened by the Program on Humanitarian Assistance World Conference on Religion and Peace, February 1994.

INTERAGENCY OPERATIONS

Many peace operations are likely to be characterized by a high degree of interagency coordination. Such coordination involves many of the agencies of the US Government, to include the Department of State, USAID, and others. Interagency operations facilitate the implementation of all elements of national power in a peace operation and as a vital link uniting Department of Defense (DOD) and other governmental departments and agencies. Interagency operations are critical to achieving strategic end states of peace operations.

Interagency operations facilitate unity and consistency of effort, maximize use of national resources, and reinforce primacy of the political element. A joint headquarters conducts interagency coordination and planning. For certain missions, the joint headquarters may delegate authority to the component for direct coordination with other agencies. In all cases, the component must ensure appropriate authority exists for direct coordination. Components may, in certain special missions, work directly with or for another government agency. In such cases, direct coordination is authorized and command arrangements are specified based on the situation.

The Office of the Secretary of Defense and the joint staff coordinate interagency operations at the strategic level. This coordination establishes the framework for coordination by commanders at the operational and tactical levels. In some cases—such as PK—Department of State (DOS) is the lead agency and DOD provides support. In others—such as PE—DOD is the lead agency.

The combatant commander is the central point for plans and implementing theater and regional strategies that require interagency coordination. The combatant commander may establish an advisory committee to link his theater strategy to national policy goals and the objectives of DOS and concerned ambassadors. Military personnel may coordinate with other US Government agencies while operating directly

under an ambassador's authority, while working for a security assistance organization, or while assigned to a regional combatant commander.

Coordination among DOD and other US Government agencies may occur in a country team or within a combatant command. Military personnel working in interagency organizations must ensure that the ambassador and combatant commander know and approve all programs. Legitimizing authorities determine specific command relationships for each operation. This command arrangement must clearly establish responsibility for the planning and execution of each phase of the operation.

In addition to extensive US Government agency coordination, commanders must also fully integrate operations into local efforts when appropriate. Such integration requires close coordination with local government agencies and bureaus; local military, paramilitary, or police forces, and multinational partners. A structure such as a mixed military working group comprised of senior officials of the military and other agencies may assist such an effort and include belligerent parties as appropriate.

LIAISON

Unity of effort is facilitated through the use of liaison officers (LNOs). LNOs are used to centralize direction and staff cognizance over planning, coordination, and operations with external agencies or forces. Commanders establish LNOs as the focal point for communication with external agencies. LNOs normally report to the operations officer. LNOs may be able to resolve interagency problems by establishing communications to facilitate control for participating forces and agencies.

LNOs should have sufficient rank and authority appropriate to their level of liaison and be identified early in the planning process. LNO teams should be staffed with sufficient personnel to conduct 24-hour operations. Senior LNOs should travel with commanders while LNO team activities are maintained.

Language qualifications and knowledge of the doctrine, capabilities, procedures, and culture of their organizations are extremely important for LNOs. CA or special operations forces (SOF) teams may be available to serve as LNOs.

The use of contracted interpreters to augment LNO teams may be another option, although in some cases their loyalties may affect their reliability.

CHAPTER 3

Planning Considerations

An integrated approach to timely planning and conduct of operations is essential, across the military and civilian components and agencies of the United Nations and the nongovernment organizations, all the way from the United Nations secretariat, to the forward area for the duration of the mission.

Lieutenant General John M. Sanderson
Companion of the Order of Australia

The complex environment, changing circumstances, and multinational and political dynamics of peace operations complicate planning. The planning process itself is the same as for other types of operations, but considerations and emphasis may be different. For example, in many peace operations, CS and CSS units execute the primary mission of the force. This chapter highlights those aspects of planning that are unique or require special emphasis in peace operations.

MISSION ANALYSIS

A clearly defined mission is the key to the successful planning and execution of a peace operation. Commanders must continually work with higher authorities to ensure that the mission is well-defined. In peace operations, the conditions for success are often difficult to define. The 10th Mountain Division (Light Infantry) translated its security mission to clearly defined end states at the operational level during the relief stage of Operation Restore Hope in Somalia in 1992-1993. See Figure 3-1.

CAMPAIGN PLAN

A campaign plan is an essential tool for linking the mission to the desired end state. Because, peace operations tend to unfold incrementally, planners develop a campaign plan that lays out a clear, definable path to the end state. Such a plan helps commanders assist political leaders visualize operational requirements for achieving the

end state. Essential considerations for developing a campaign plan in peace operations include understanding the mandate and TOR, analyzing the mission, and developing the ROE. A concept for transition and termination is absolutely essential to the campaign plan. Planners consider the media, NGOs, PVOs, and coalition partners and allies as primary players. Planners also consider friendly and belligerent party centers of gravity. See Appendix E for a sample campaign plan.

Transitions may occur from one kind of operation to another, such as from PE to PK or PK to PE, between authorizing entities, and during conflict termination. Transitions may involve the transfers of certain responsibilities to nonmilitary civil agencies. NGOs and PVOs may be responsible for the ultimate success of the peace operation, perhaps with significant US support, to include military forces. Transitions in peace operations may have no clear division between combat and peacetime activities, they may lack

Figure 3-1. UNITAF Security Operations

	SECURITY	END STATE
Intelligence	<ul style="list-style-type: none"> • Continue IPB process • Monitor bandit and faction leaders. Determine their intentions • Determine the political ambitions and end states • Conduct reconnaissance (LRSD, SOF, CA, Ci, Avn, Inf, Cav) 	<ul style="list-style-type: none"> • Enhanced security environment for HA operations • Somalis move freely about their country • Bandits no longer operate • Weapons not visible • Crew-served weapons in storage or confiscated • Open passage along major routes sustained • No technicals¹ • Somali police forces established • UN peacekeeping forces take over security missions
Maneuver	<ul style="list-style-type: none"> • Establish checkpoints and roadblocks • Dismantle "toil" checkpoints • Conduct area and route recons • Secure storage and distribution sites (augment others) • Establish QRF/Reserve 	
Fire Support	<ul style="list-style-type: none"> • Provide on-call assets • Provide show-of-force flyovers 	
Mobility Counter-mobility Survivability	<ul style="list-style-type: none"> • Provide mine detection and clearing • Establish survivability positions for roadblocks and base camps • Improve ground LOCs to minimum standards 	
Combat Service Support	<ul style="list-style-type: none"> • Support assigned forces • Establish logistical support bases • Secure logistics facilities 	
C 3	<ul style="list-style-type: none"> • Maintain communications with all sites • Develop command structure prepared to accept coalition forces 	
Coordination	<ul style="list-style-type: none"> • Work with humanitarian agencies • Empower elders • Assist clan leaders in keeping peace • Investigate, adjudicate, and pay foreign claims 	
Force Protection	<ul style="list-style-type: none"> • Provide security for soldiers • Improve base camps • Provide mature medical support for soldiers 	
Information	<ul style="list-style-type: none"> • Continue PSYOP themes • Provide credible information systems for the public • Provide public affairs information for each mission 	
Operation System	<p>RELIEF STAGE END STATE</p> <ul style="list-style-type: none"> • People live in peace without reliance on their own weapons for protection • Humanitarian agencies operate uninterrupted • Market economy begins 	
Stage of the Operation	<p>Adapted from a 10th Mountain Division chart used during UNITAF Operations in Somalia (Operation Restore Hope) in 1992-1993</p>	

definable timetables for transferring responsibilities, and be conducted in a fluid, increasingly political environment.

US authorities, must determine when the conditions for the desired military end state are achieved. The transition to postconflict activities is decided by higher authorities. Some guide-lines to this process which should commence prior to the introduction of peace operations forces may include—

- Achievement of a successful end state.
- Determination of correct players such as local government agencies, US agencies (DOS, USAID, United States Information Agency [USIA] as a minimum), NGOs and PVOs, regional powers, belligerent representatives, and other military forces.
- Types of activities required such as security assistance and electoral assistance.
- Determination of centers of gravity of belligerent parties.

PE forces should plan to exit the area when the agreements and buffer zones are formalized and should not attempt to transition to PK. The hand-over of operations and facilities should occur much like relief-in-place operations. Of prime importance are the establishment of liaison, linguistic assistance, sequencing of incoming and outgoing forces (combat, CS, and CSS), and coordination of logistics and equipment left in place.

USE OF FORCE

The proper use of force is critical in a peace operation. The use of force to attain a short-term tactical success could lead to a long-term strategic failure. The use of force may affect other aspects of the operation. The use of force may attract a response in kind, heighten tension, polarize public opinion against the operation and participants, foreclose negotiating opportunities, prejudice the perceived impartiality of the peace operation force, and escalate the overall level of violence. Its inappropriate use may



In peace operations, as in military operations, the inherent right of self-defense applies.

embroil a peace operation force in a harmful long-term conflict that is counterproductive to the overall campaign objectives.

In PK, commanders should regard the use of force as a last resort; in PE, commanders should exercise restraint in employing force. In either case, sufficient force must be available to—

- Achieve objectives rapidly through simultaneous application of combat power.
- Protect the force.

In peace operations, as in all military operations, the inherent right of self-defense applies.

ALTERNATIVES

Commanders should consider all possible alternatives to the use of force before taking action. Peace operations demand restraint in the employment of force, as settlement—not victory—remains the objective. Alternatives to use of force include the following measures.

Deterrence

The skillful use of deterrent measures may avoid the use of force. The interposition of forces or a deployment in strength are effective deterrent measures. The presence of sufficient force at the scene of a potential incident tends to diminish the confidence of a would-be aggressor and allow the commander on the spot a wider number of options to counter an incident.

Mediation and Negotiation

Mediation and negotiation may be helpful in reconciling differences among belligerent parties. They are effective tools in improving relations among belligerent parties and the peace operations force. In many societies, self-esteem and group honor are of great importance. The use of simple face-saving measures to preserve a party's dignity may serve to relax tension and defuse a crisis.

Commanders of PK forces may find themselves in the role of negotiator, mediator, and even arbitrator of a confrontation. If possible, negotiations on matters affecting all parties should be carried out jointly with all belligerent parties present. They should be conducted by specially organized negotiation teams that express neutrality to the belligerent parties.

On occasion, relations among belligerent parties may be so strained that a third party has to act as an intermediary. A negotiator must be firm, fair, and polite if he is to gain and keep the trust of all parties. Negotiators must be tactful, resourceful, objective, impartial, and patient; have a sense of proportion; and be painstakingly attentive to detail. On matters of principle, a negotiator must be insistent without being offensive and must be careful not to pass the confidences of one side to another.

Negotiations are not always successful. Agreements by all belligerent parties may or may not occur. The negotiator must remember to remain impartial and courteous and avoid being used by any belligerent. He might expect some belligerent parties to negotiate in bad faith. They may attempt to twist the issues to prolong negotiations while they continue to violate previously agreed-upon settlements. Negotiations are time-consuming and often frustrating; however, they can prevent unnecessary loss of life and offer the best long-term prospect for a final peaceful settlement.

Population and Resource Control

Control measures, such as roadblocks, cordons, curfews, access control, and checkpoints, may contribute to avoiding the use of force.

Rewards and Penalties

Rewards and penalties such as granting or denying access to key routes used by belligerent parties may shape behavior and cooperation. However, the potential exists for propaganda by the belligerent parties. They may convince the populace that the peace operations force is unfairly denying needed resources.

Warnings

Belligerent parties may be given specific warnings that continued hostile activities may be met with the use of force.

Other Measures

Restrained use of force consists of physical means not intended to harm individuals, installations, or equipment. Commanders should develop measured responses and train in the restrained use of force for peace operations.

Examples are the use of vehicles to block the passage of persons or vehicles and the removal of unauthorized persons from unit positions. In limited circumstances, commanders may use force that may result in physical harm to individuals, installations, or equipment. When properly authorized, the use of incapacitants such as riot control agents and riot batons may preclude the need to resort to more lethal measures. These means are more suitable for use in PE and are seldom used in PK.

RULES OF ENGAGEMENT

In peace operations, well-crafted ROE can make the difference between success and failure. ROE are directives that delineate the circumstances and limitations under which US forces initiate and/or continue engagement with belligerent forces.

In peace operations, ROE define when and how force may be used. ROE may reflect the law of armed conflict and operational considerations but are principally concerned with restraints on the use of force. ROE are also the primary means by which commanders convey legal, political, diplomatic, and military guidance to the military force.

ROE are developed by military commanders and must consider the direction and strategy of political leaders. This process must balance mission accomplishment with political considerations while ensuring protection of the force. In all cases, restraint remains a principle of peace operations and should guide ROE development, particularly in light of collateral damage, post-conflict objectives, desired end states, and the legitimacy of the operation and authorities involved.

Intent

ROE seldom anticipate every situation. Commanders and leaders at all levels must understand the intent of the ROE and act accordingly. The commander responsible for ROE formulation should consider including an intent portion that describes the desired end state of the operation as well as conflict termination considerations. Rehearsing and wargaming ROE in a variety of scenarios will help soldiers and leaders better understand the ROE.

Dissemination

All commanders must instruct their forces carefully concerning ROE and the laws that govern armed conflict. ROE should be included in OPLANs and OPORDs and address all means of combat power. Fire support ROE is as important as individual weapons ROE. The staff judge advocate (SJA) should review all ROE. ROE should be issued in an unclassified form to all personnel, who should adhere to them at all times, notwithstanding noncompliance by opposing forces.

Multinational Interpretation

ROE in multinational operations can create unique challenges. Commanders must be aware that there will most likely be national interpretations of the ROE. Close coordination of ROE with multinational partners may preclude problems.

Varied Circumstances

ROE vary in different operations and sometimes change during peace operations. The ROE must be consistent at all levels of command. Nothing in the ROE should negate a commander's obligation to take all necessary and appropriate action to protect his force. Additionally, the ROE in peace operations may establish guidance for situations such as the search and seizure of inhabitants, the authority of local security patrols, the prevention of black market operations, the surrender of hostile personnel, and the protection of contractor personnel and equipment in support of US operations.

Changes

Commanders at all levels need to know how to request changes to ROE. ROE are developed with political considerations in mind and are approved at a high level of authority. However, the requirement to change the ROE may result from immediate tactical emergencies at the local level; introduction of combat forces from a hostile nation; attacks by sophisticated weapon systems, including nuclear, biological, or chemical (NBC); or incidents resulting in loss of life. Commanders should anticipate these situations and exercise request channels.

Execution

Commanders should be firm and determined when executing ROE in peace operations. If the peace operations force is seen to lack confidence, it may be further challenged, resulting in an unnecessarily high level of response or escalation in the overall level of violence. Commanders should thoroughly plan the manner in which force is to be used and rehearse anticipated actions. Finally, ROE must be impartially applied in PK. In PE, this guideline may not apply fully. Even in PE, however, use of force without prejudice remains important. Appendix D provides sample ROE.

FORCE PROTECTION

Commanders attempt to accomplish a mission with minimal loss of personnel, equipment, and supplies by integrating force protection considerations into all aspects of operational planning and execution. Force protection consists of operations security (OPSEC), deception, health and morale, safety, and avoidance of fratricide.

OPERATIONS SECURITY

In peace operations, OPSEC includes such areas as communications security, neutrality, photography, sites, accommodations and defensive positions, roadblocks, personnel vulnerabilities, personal awareness, security measures, sniper threats, coordination, and evacuation.

Communications Security

Communications security (COMSEC) is as important in peace operations as it is in conventional military operations. Belligerent parties can monitor telephone lines and radios. However, in PK the need to maintain transparency of the force's intentions is a factor when considering COMSEC.

Neutrality

Maintaining neutrality contributes to protecting the force. Manifest neutrality and evenhandedness could afford the force a measure of protection. In peace operations, the entire force should safeguard information about the deployment, positions, strengths, and equipment of one side from the other. If one side suspects that the

force, either deliberately or inadvertently, is giving information to the other side, it could result in accusations of espionage. One or both parties to the dispute may then become uncooperative and jeopardize the success of the operation, putting the force at risk.

Photography

Prohibiting photography of local areas or people might contribute to neutrality. However, this should not impede collection efforts in support of protecting the force.

Sites, Accommodations, and Defensive Positions

Precautions should be taken to protect positions, headquarters, support facilities, and accommodations. These may include obstacles and shelters. Units must also practice alert procedures and develop drills to rapidly occupy positions. A robust engineer force provides support to meet survivability needs. When conducting PE, units should maintain proper camouflage and concealment. Additional information on precautions is provided in FM 5-103, TM 5-585, and FM 90-10.

Roadblocks

Military police (MP) forces may establish and maintain roadblocks. If MP forces are unavailable, other forces may assume this responsibility. As a minimum, the area should be highly visible and defensible with an armed overwatch.

Personnel Vulnerabilities

A peace operation force is vulnerable to personnel security risks from local employees and other personnel subject to bribes, threats, or compromise.

Personal Awareness

The single most proactive measure for survivability is individual awareness by soldiers in all circumstances. Soldiers must look for things out of place and patterns preceding aggression. Commanders should ensure soldiers remain alert, do not establish a routine, maintain appearance and bearing, and keep a low profile.

Sniper Threats

In peace operations the sniper is a significant threat. Counters include rehearsed responses, reconnaissance and surveillance, barriers, shields, and screens from observation. ROE should provide specific instructions on how to react to sniper fire, to include restrictions on weapons to be used. Units can use specific weapons, such as sniper rifles, to eliminate a sniper and reduce collateral damage.

Security Measures

Security measures are METT-T-dependent and may include the full range of active and passive measures such as patrolling, reconnaissance and surveillance, and use of reaction forces.

Coordination

Commanders should coordinate security with local military and civil agencies and charitable organizations whenever possible.

Evacuation

A PK force may need to evacuate if war breaks out or if the host nation withdraws its consent to the mandate. In a UN operation, the UN force headquarters develops a plan to evacuate all PK forces. The evacuation plan should include appropriate routes for ground, sea, or air evacuation. All units should rehearse their evacuation plan and develop contingency plans that cover tasks such as breakout of an encirclement or fighting a delaying action.

DECEPTION

During PK, the requirement for transparent operations normally precludes deception measures. However, these measures may be appropriate during PE.

HEALTH AND MORALE

Peace operations often require special consideration of soldier health, welfare, and morale factors. These operations frequently involve deployment to an austere, immature theater with limited life support systems. In addition, peace operations place unique demands, such as periods of possible boredom while manning observation posts or checkpoints, on soldiers. Soldiers

must deal with these stresses while under the constant scrutiny of the world press. Commanders must consider these factors when assigning missions and planning rotations of units into and within the theater.

SAFETY

Commanders in peace operations may reduce the chance of mishap by conducting risk assessments, assigning a safety officer and staff, conducting a safety program, and seeking advice from local personnel. The safety program should begin with training conducted before deployment and be continuous. Training will include factors that could have an effect on safety, such as the environment, terrain, road conditions and local driving habits, access or possession of live ammunition, unlocated or uncleared mine fields, and special equipment such as tanks and other systems that present special hazards. Safety is also important during off duty and recreational activities. If possible, the safety officer and staff should coordinate with local authorities concerning environmental and health concerns. US force presence should not adversely impact the environment.

AVOIDANCE OF FRATRICIDE

Most measures taken to avoid fratricide in peace operations are no different than those taken during combat operations. However, commanders must consider other factors such as local hires or NGO or PVO personnel that may be as much at risk as US forces. Accurate information about the location and activity of both friendly and hostile forces (situational awareness) and an aggressive airspace management plan assist commanders in avoiding fratricide. LNOs increase situational awareness and enhance interoperability. Use of night vision light-intensifier devices aids units in target identification during limited visibility. ROE might prevent the use of some weapon systems and lessen the risk of fratricide. The collateral effects of friendly weapons in urban and restricted terrain can affect fratricide. Soldiers must know the penetration, ricochet, and blast consequences of their own weapons.

FORCE TRAINING

The most important training for peace operations remains training for essential combat and basic soldier skills. Leader development in schools will further provide the requisite knowledge, skills, and attitudes required in peace operations. The unique aspects of peace operations should be addressed in predeployment training with the assistance of mobile training teams (MTTs), training support packages (TSPs), and, if time permits, training at combat training centers (CTCs). Commanders should consider sustainment training during mission execution, if possible, and postoperations training. Joint and multinational unit and staff training is also important. See Appendix C for more details concerning training.

FORCE TAILORING

In planning for peace operations, the commander must tailor a force suitable for the mission. It should be based on a unit's ability to contribute to achieving national interests and objectives and perceptions of the indigenous population, the international community, and the American public. Commanders should also consider the synergy and enhanced capabilities inherent in joint operations when tailoring the force. Building teamwork early and continually is vital to success when forces are rapidly tailored for mission.

The force must be appropriate to the stated goals of the sponsoring authority and provide sufficient capability to deploy, complete the mission, and protect itself. The perception that employed forces exceed the limits of the mandate weakens legitimacy. Suitability varies based upon the threat, the intensity of operations, the missions to be performed, and changing international perceptions. Commanders should prepare for worst-case situations by planning for the employment of combined arms assets.

Reserve component soldiers and units may be included in the US force under specific authority, usually under a Presidential Selected Reserve Call-Up. The authority carries with it unique planning requirements. FM 100-17¹ covers these considerations in detail.

¹. *Mobilization, Deployment, Redeployment, Demobilization*, 28 October 1992.

Historical Perspective

Throughout Operation Restore Hope, MP units were in great demand because of their ability to serve as a force multiplier. Marine force (MARFOR) and ARFOR commanders quickly took advantage of the MP's significant firepower, mobility, and communications and used them effectively as a force multiplier conducting security-related missions as one of their combat forces. Doctrinal missions included security of main supply routes (MSRs), military and NGO convoys, critical facilities, and very important persons (VIPs); customs; detention of local civilians suspected of felony crimes against US force or Somali citizens; and criminal investigative division (CID) support as the JTF's executive agency for joint investigations. MPs responded to a significant number of hostile acts taken against US forces, NGOs, and civilians by armed bandits and technicals (see Figure 3-1) and to factional fighting that threatened US forces or relief efforts. They also supported the JTF weapons confiscation policy by conducting recons and gathering information and intelligence (human intelligence [HUMINT]) about the size, location, and capabilities of factions operating throughout the ARFOR and MARFOR AOs. This information included the location of sizeable weapons caches. MPs also had an expanded role in the actual confiscation of weapons by establishing checkpoints and roadblocks along MSRs, within small villages, and within the congested, confined urban environment of Mogadishu. Serving in both a combat and CS role, MPs also participated in a larger, combined arms show-of-force operation (air assault) in the city of Afgooye.

Commanders must recognize the availability and contribution of civilians and contractors as part of the total force. Civilians may participate to provide expertise that is not available through uniformed service members and to make the most effective use of government resources. Support provided by civilians in past conflicts included, but was not limited to, communications, intelligence, contract construction, real estate leasing, water detection, civil engineering technical assistance, and logistics services. Civilians in the nonappropriated fund category provide morale, welfare, and recreation programs and staff the service exchanges.

AUGMENTATION AND LIAISON

The unique aspects of peace operations may require individual augmentees and augmentation cells to support unique force-tailoring requirements and personnel shortfalls. Augmentation supports coordination with the media, government agencies, NGOs and PVOs, other multinational forces, and civil-military elements. METT-T considerations drive augmentation. Augmentation requires life support, transportation, and communication. Liaison requirements are extensive in joint and multinational operations. Commanders must provide augmentees with resources and quality of life normally provided to their own soldiers.

Commanders may consider task-organizing small liaison teams to deal with situations that develop with the local population. Teams can free up maneuver elements and facilitate negotiation. Unit ministry, engineers, CA, counterintelligence, linguists, and logistics personnel may be candidates for such teams. Commanders ensure that teams have transportation and communication allocated.

Special negotiation teams may be formed that can move quickly to locations to diffuse or negotiate where confrontations are anticipated or occur. Teams must have linguists and personnel who have authority to negotiate on the behalf of the chain of command.

SPECIAL TECHNOLOGY

In tailoring the force, commanders must weigh the appropriateness of using technology

based on the nature of the mandate, maintenance requirements, local sensitivities, skills required for operation, and other factors. Technology available from battle laboratory experiments, even in small numbers, can make a big difference. Commanders of operations, however, must decide on its use consistent with mission accomplishment.

Aircraft normally used for transport may conduct air surveillance. Satellites, scout aircraft, unmanned aerial vehicles, airborne reconnaissance low (ARL), or the joint surveillance and target attack radar system (J-STARS) are other means of air surveillance. Ground surveillance technology such as radar, night vision devices, sensors, and thermal sights may also be useful in peace operations. All such devices may be especially useful in observing and monitoring situations.

Another category of technology with which soldiers may be less familiar is a broad category of instruments that may assist forces in conducting operations in consonance with the principle of restraint and minimal force. Types of weapons are those that could disrupt communications, radar, computers, or other communications or stop belligerent parties without killing or maiming them, weapons that could disrupt or interdict supply routes or make equipment inoperable, or those that could disarm combatants without killing or maiming them. This category requires special consideration of the rules of war or treaties concerning war or humanitarian practices, unintended environmental or personnel effects, availability and state of development, and postconflict activities or requirements.

COMBAT FUNCTIONS

Combat functions apply in peace operations. Commanders must exercise judgment in applying them to these operations. Some functions may apply differently in peace operations than in war. An example is maneuver in the sense of movement to gain relative advantage over an enemy. In peace operations, maneuver may contribute to achieving situational advantage over a belligerent rather than destruction of an enemy. Intelligence is another example of unique applications. Figure 3-1 is an example of using force

protection, coordination, and information dissemination as functions appropriate to the peace operation situation. The following selected combat functions may apply to peace operations.

MANEUVER

Maneuver warfare and the applications of direct fires in support of it do not lend themselves to all forms of peace operations, particularly PK. On the other hand, armored forces and attack helicopter assets may, for example, play major roles in preventive deployments and PE and be useful in PK for force protection, deterrence, convoy escort; for personnel transport where threats exist, or as a mobile reserve.

Geographic locations of buffer zones or demilitarized areas may severely restrict maneuver. The force commander may have little latitude in adjusting the zone since it may be the result of political, ethnic, and religious considerations. Conversely, the force commander may have to spread forces thinly to accommodate missions such as checkpoints and observation posts.

Forces conducting PE, particularly operations to separate belligerent parties, may find it necessary to employ certain basic maneuvers in order to accomplish the separation mission. These maneuvers may include attacks to seize key terrain features in a buffer zone. In such instances, the objective is the seizure of terrain, not the destruction of the belligerent force.

Special Operations Forces

Army special operations forces (ARSOF) are a valuable asset when planning peace operations. For example, ARSOF can help prepare the AO through normal SOF activities designed to gain intelligence updates on key and local personnel and facilities, especially in PE. ARSOF can contact local agencies and friendly authorities, establish surveillance over the planned points of entry, or conduct operations to prevent the synchronized defense or counterattack by hostile forces. They can also provide up-to-the-minute weather and intelligence.

A ranger force can support conventional military operations or it may operate independently when conventional forces cannot be used. Ranger forces can typically perform direct-action

missions such as strike operations, tactical reconnaissance, and special light infantry operations.

Special Forces. Special Forces (SF) assets deployed rapidly in denied or hostile areas can collect intelligence through area surveillance and reconnaissance. They can provide initial assessments in the areas of engineering, medical, security, and intelligence. With their language and area orientation, they can provide liaison with the local population, multinational forces, non-military agencies, and other military organizations.

SF may assist in training and organizing local security forces. They may also enhance multinational interoperability by cross training with these forces. In humanitarian assistance operations, they can assist in providing and securing relief supplies.

In peace operations, SF may execute precision strikes to destroy certain facilities and military capabilities by employing terminal guidance techniques for precision-guided munitions. SF may also be used to preclude or preempt terrorist activities and to conduct liaison with local militias.

Psychological Operations Forces. PSYOP can play an important role in facilitating cooperation between belligerent parties and peace operation forces. Tactically, PSYOP forces can assist through persuasion rather than intimidation. Through the use of local information programs, such as radio or television newscasts and leaflet distribution, PSYOP elements can ensure the operational objectives and efforts are fully understood and supported by the target audience.

Civil Affairs Units. CA in peace operations may include activities and functions normally the responsibility of a local government. CA units can assess the needs of civil authorities, act as an interface between civil authorities and the military supporting agency and as liaison to the civil populace, develop population and resource control measures, and coordinate with international support agencies. CA units are regionally oriented and possess cultural and linguistic knowledge of countries in each region. The civilian skills CA units possess allow them to assess and coordinate infrastructure activities. CA units

are responsible for establishing and managing camps. The legal status of individuals within the camps is dependent upon the type of operation and the legal mandate establishing it.

Historical Perspective

Soon after peace operations began in the Dominican Republic, the 1st Psychological Warfare Battalion deployed with various types of broadcasting and printing facilities. Loudspeaker trucks proved to be very effective in imparting information. Wherever the trucks stopped, large crowds of Dominicans gathered to hear the latest news and receive leaflets and pamphlets. The unit ran a radio station powerful enough to reach into the interior of the island. The US Information Service determined the themes and tightly controlled all the battalion's activities. The combined CA and PSYOP activities were very effective in the Dominican Republic, as indicated by one of the most frequent pieces of graffiti: "Yankee go home—take me with you."

Historical Perspective

The 353d CA Command (-) and the 354th CA Brigade were two USAR commands completing their Desert Storm CMO support missions in Saudi Arabia, when they were redeployed in April 1991 to conduct Kurdish relief operations in southeastern Turkey and northern Iraq. An element of the 96th CA Battalion (Airborne) deployed from Fort Bragg, NC, to assist in the Provide Comfort humanitarian relief operation. The 354th CA Brigade HQ, with three companies augmented the 353d CMO Section of the multinational combined staff, established a task force to facilitate transfer of military relief operations to civilian agencies, and assisted in moving the Kurds from the mountains, through temporary

transit support sites, to their homes. CA support included provision of medical and water distribution assistance to SF teams in the mountains; establishment, initial operation, and turnover of transit centers to the United Nations High Commissioner for Refugees (UNHCR); and support of over 40 civilian humanitarian relief agencies in moving people and supplies to numerous relief sites.

Planners must consider end state and transition strategies when planning, building, and managing camps. They must plan for the assimilation of private relief agencies and NGOs and PVOs early in the process. Funding and budgeting considerations must be resolved early in order to expedite hand-off of facilities and responsibilities to other forces and agencies.

Historical Perspective

On 16 April 1991, the President of the US, authorized by UN resolution 688, expanded Operation Provide Comfort to include multinational forces with the additional mission of establishing temporary refuge camps in northern Iraq. Combined Task Force (CTF) Provide Comfort would oversee the building of shelters and distribution of supplies, ensure order, and provide security throughout this area. The provision of security was essential to get the Kurds to move from the mountains back to their homes and transfer the responsibility for them from the military to international agencies. The camps were designed to reflect the cultural realities of the Kurds. They were built around five-person tents, a 66-person tent neighborhood (Zozan); a 1,056-person tent village (Gund); a 2,500-person tent community (Bajeer) and in the center, the community center and administration area.

Military Police

MPs in peace operations can project a force signature that may be more politically acceptable to the international community and the US public. The domestic and international acceptance of MPs as a force focused on security, protection, and assistance provides the commander the use of a highly capable and versatile force without a significantly increased force signature.

While peace operations may detract from a combat unit's primary mission of training soldiers to fight and win in combat, peacetime MP training and operations support many peace operation missions, particularly those that emphasize minimal use of force. As a direct result of their peacetime daily law-and-order missions, MPs and the CID are continually trained in the prudent use of force, crisis management, and operations requiring restrictive ROE. MP and CID are trained and experienced in demonstrating understanding and compassion in dealing with the civilian population. They are also trained to understand how and when to transition from restrictive ROE to lethal force if required or directed.

FIRE SUPPORT

Fire support assists commanders in the careful balancing of deterrent force with combat power to accomplish the peace operation mission and protect the force. Precision munitions play an important role. Mortars, due to their smaller bursting radius, may reduce the possibility of collateral damage—a critical consideration during peace operations. They may provide illumination rounds as a deterrent demonstration of capability, for observing contested areas, for supporting friendly base security, or for patrolling maneuver forces.

Artillery fires—in particular rockets and rounds with ordnance, though relatively selective and accurate—involve a significantly higher possibility of collateral damage. In addition, unexploded ordnance can pose a safety hazard to the indigenous population and/or provide a local combatant the building blocks of an explosive device. Commanders should be cautious in using artillery fires in general and in selecting an appropriate munition to minimize collateral

damage and the threat to both friendly forces and local populations.

Field artillery howitzers and rocket systems provide both a continuous deterrent to hostile action and a destructive force multiplier for the commander. To deal with an indirect fire threat, the force may deploy artillery- and mortar-locating radars for counterfire. Firefinder radars can also document violations of cease-fire agreements and fix responsibility for damage and civilian casualties.

AC-130 aircraft, attack helicopters, and observation/scout helicopters are important target acquisition, deterrent, and attack assets in peace operations. Tactical air (TACAIR) can provide selective firepower, particularly in the employment of precision-guided munitions. Collateral damage and unexploded ordnance are significant planning factors when considering the employment of TACAIR.

Fire support coordination, planning, and clearance demands special arrangements with joint and multinational forces and local authorities. These include communication and language requirements, liaison personnel, and establishment of procedures focused on interoperability. Excellent examples of coordinated fire support arrangements are the NATO standardization agreements (STANAGs). These provide participants with common terminologies and procedures. ROE should provide guidelines for clearance of indirect fires (both lethal and nonlethal).

AIR DEFENSE

PE requires forces to be thoroughly trained on passive and active air defense measures. Soldiers must be trained on visual aircraft recognition and ROE due to the possibility of like aircraft being flown by more than one of the forces involved. Air defense considerations are of great importance in PE operations that deny or guarantee movement or enforce sanctions.

Belligerent parties may employ extensive measures such as cover and concealment, hand-held surface-to-air missiles (SAMs), and light air defense artillery (ADA) weapons to protect themselves from air attack. Since many targets

will be in belligerent-controlled areas, commanders must weigh the potential loss rate of aircraft against the returns that air interdiction missions might produce. However, they should also consider that curtailment of rotary and low-level fixed-wing operations is one of the goals of the belligerent.

BATTLE COMMAND

A key challenge occurs in battle command. Intuitive skills of commanders, an element of battle command, are especially appropriate to the ambiguities and uncertainties of the peace operations environment discussed in Chapter 1 and in managing the variables of peace operations. Training, situational drills, and constant study and reading of changing patterns sharpens this intuitiveness.

Battle command recognizes the inevitable co-existence of both hierarchical and non-hierarchical organizations, systems, and players in peace operations, both military, interagency, multinational, and NGOs. Digitization and information technology will permit greater situational awareness, empower individual soldiers to act appropriately under varying circumstances, and reduce the probability of fratricide and collateral damage.

Peace operations pose various challenges to signal support functions. First and foremost is the level of complexity and coordination required to effect the maximum use of available signal support. Early deployment of signal planners and use of joint doctrine and TTPs are critical.

Communications systems are difficult to standardize, given the wide range of available commercial and military assets. The integration of multinational and US signal support is extremely important in transition planning and execution of the various dimensions of peace operations. An overall network manager and system interoperability criteria are critical to successful communications.

Incompatibilities among systems, standard operating procedures (SOPs), and doctrine can be expected in multinational operations. These operations require careful consideration of

equipment capability and procedural and cultural differences among all coalition forces. Incompatibilities must be overcome to sustain command and unity of effort during joint and multinational operations.

All nations share the electronic spectrum and reserve their right to its unlimited use. Spectrum managers at all echelons must be aware of what equipment is being used in their vicinity to ensure negligible mutual interference. LNOs must facilitate close coordination with friendly local or multinational forces in close proximity.

Commercial communications may be austere. Deploying forces must not depend on local commercial communications. Even when commercial communications are available, the presence of US forces puts a burden on that capability. Signal planners must consider transition and funding of communications functions to local authorities, the UN, or other forces assuming the support mission. Functions left behind for the host nation or multinational forces may overwhelm them unless the transition is gradual and begins several months before the organic signal units departure. In an austere theater, commanders should be prepared to provide media access to communication assets, as long as it does not interfere with critical military operations.

MOBILITY AND SURVIVABILITY

To ensure a mobile, survivable force, both engineer and chemical forces provide essential support during peace operations.

Engineer Forces

Planners consider all available engineer capabilities, to include *other services*, multinational forces, contractors, and troop units (including reserve components). The latter requires greater reaction time than active component engineers. Planners consider the specific capability and availability of the units when building the force, along with facilities available for leasing and the infrastructure. The joint task force contingency engineer manager (JTFCEM) normally provides staff assistance to the JTF commander, who controls engineer assets. Similar considerations apply to multinational forces.

Planners must consider interoperability to ensure that assets are complementary, if not compatible. Engineer planners also consider personnel or material assets available through contracts, local sources, and private agencies, including the Logistics Civil Augmentation Program (LOGCAP).

Engineer operations require large amounts of construction materials which may be acquired locally, regionally, and from CONUS. These materials may be obtained through military supply channels or by contract. Engineers identify, prioritize, and requisition required construction material consistent with acquisition regulations. Supply units process the requisition and acquire, receive, store, and transport construction materials. This support may be also be provided through a combination of engineer unit Class IV acquisition and storage by LOGCAP contractor support.

Chemical Units

Commanders must consider the requirement for chemical support of peace operations if evidence exists that belligerent forces have employed agents or have the potential for doing so. In addition, when authorized, riot control agents may be selectively employed as an alternative to deadly force in certain peace operations. A mix of different units (decontamination units, NBC reconnaissance elements, and smoke units) are often necessary to achieve the proper balance of capabilities. Additional capabilities include providing vector control and limited water transfer, spray, and storage. Chemical staff officers may advise on commercial chemical threats as well as on the collection, packaging, storage, disposal, and cleanup of hazardous materials and wastes.

INTELLIGENCE

Successful intelligence support during peace operations relies on continuous peacetime information collection and intelligence production. Increased reliance on HUMINT sources may often be necessary. Furthermore, it is necessary to collect information on all parties to the conflict and other peace operations forces as well

Historical Perspective

Operation Restore Hope demonstrated the usefulness of engineers in operations other than war. Somalia's austere landscape and climate posed challenges similar to or greater than the ones encountered during Operations Desert Shield/Storm, including a harsh desert environment, resupply over great distances, limited resources, and a devastated infrastructure.

The deployed engineer force was a joint and multinational effort, building on the engineer capabilities found with each service component and coalition partner. Engineers provided standard maps and imagery products, detected and cleared hundreds of land mines and pieces of unexploded ordnance, built base camps for US and coalition forces, and drilled water wells. They constructed and improved over 2,000 kilometers of roads, built and repaired several Bailey bridges, upgraded and maintained airfields, and participated in local civic action projects that helped open schools, orphanages, hospitals, and local water supplies.

Army engineers cooperated fully with and complemented engineer capabilities found within the US Marine Corps, US Navy, and US Air Force. In addition, coalition force engineer efforts were fully coordinated with US and UN goals for the area.

to understand and appreciate varying perspectives and methods of operation. Special equipment such as night observation devices and thermal imagery devices, as well as special surveillance aircraft, will also be useful in peace operations.

The intelligence needs of the commander involved in peace operations are in some ways more complex than those of the commander conducting combat operations in war. Regardless of the mission, the commander must be prepared for direct attack, either by one of the parties to the deployment agreement or by extremist elements acting independently. Peace operations are often conducted in a joint, and, most probably, a multinational and/or UN operational environment. The commander and his staff must understand and apply the current joint intelligence doctrine in Joint Publication 2-0² to each new peace operations environment. This may be compounded by the intricacies of dealing in an interagency arena where different agencies have different rules. When conducting multinational operations, sharing information with allies may in itself become an issue. In PK, the terms *information* and *intelligence* are synonymous. For instance, in PK, there is an information officer in addition to or in lieu of an intelligence officer as in other operations. In PE, the intelligence function is employed with sufficient assets and focus to support necessary combat operations. A joint operations support element (JOSE) or other specially organized intelligence assets may be needed.

Peace operations often require augmentation of the intelligence staff. In particular, the commander-in-chief's (CINC's) staff must recognize that available communications may preclude effective use of the normal channels for requesting and providing intelligence; therefore, commanders must tactically tailor the force to ensure communications, processing capability, and down-links are available for broadcast dissemination of intelligence.

The supporting CINC normally provides detailed analytical support to the deploying commander through split-based operations. This includes anticipating and initiating collection against long lead-time requirements, synthesizing available information on the AOs and orchestrating the collection efforts of existing intelligence organizations. The degree of support needed depends on the size and sophistication of the deploying unit's intelligence staff and should

be tailored as the operation develops to ensure seamless intelligence support. The supporting CINC can make a major contribution to the deploying commander simply by ensuring at the outset that intelligence is decompartmented and releasable to multinational units.

Intelligence Analysis in Peace Operations

Success for the intelligence officer in peace operations depends on a thorough understanding of the situation. This understanding often focuses on what were formerly considered *non-military topics*, such as politics, economics, and demographics. The intelligence officer must consider political objectives that drive military decision making at every level. This means final decisions on military intelligence operations may be made by nonmilitary personnel, such as a UN representative or the senior US State Department official at the scene. Further, the intelligence officer may have to markedly revise his concept of threat, to include multiple belligerent parties, terrorists (possibly from outside the area of conflict), and local nationals nursing a wide range of grievances. In addition, a friendly or neutral force may become hostile because of some real or perceived failure of the US force to treat them fairly. The intelligence officer must know the entire situation and the current status of all the players.

Intelligence-Preparation-of-the-Battlefield

The principal difference between intelligence-preparation-of-the-battlefield (IPB) for conventional battlefield situations and peace operations is the focus and degree of detail required to support the commander's decision-making process. Another major difference is the enormous demand for demographic analysis and templates. New information categories begin to emerge for the commander as he directs troops and accomplishes missions in an unfamiliar environment.

Expand the Area of Interest. Analysis should include all military and paramilitary forces and NGOs that may interact with US troops. Intelligence analysts should consider political groups, media, and third nation support to belligerent forces.

² *Intelligence Operations*, 30 June 1991 (Test Pub).

Analyze Terrain and Infrastructure. Intelligence analysts consider the legal impact of the mandate, TOR, geographic boundaries, and other limitations upon both peace operation and belligerent forces. They identify existing and traditional infrastructures. In an unfamiliar environment, analysts should assess other features such as small villages, nomadic camp sites, food sources and food distribution points established by civilian relief organizations, water sources (ground or surface or artesian wells), guard shacks and towers, perimeter fences, surveillance cameras or other warning devices, animal grazing sites, religious monuments, cemeteries, local places of worship, hospitals, boat ramps, local gas stations, and telephone exchanges. In essence, they should analyze the environment to the smallest possible detail.

Analyze the Local Area. Analysts consider the population, government, available transportation, demographics, status of utilities, warehouse storage, and so on. The analysis includes housing, the health of the population, hospitals, population distribution, ethnic backgrounds, languages, and religious beliefs; tribe, clan, and subclan loyalties; political loyalties to the national government; loyalties to the de facto government; holiday and religious observances practiced by the local populace; monetary systems and currencies used by the populace; and black-market activities conducted within the AI. Analysts identify the best case and worst case time lines of the operation.

Describe Effects. Analysts consider the impact of demographic and social data on the overall operation. They identify the root causes of the conflict and analyze them from the perspective of all belligerent parties. They ask themselves, "What would have to happen to bring peace to the region? Can belligerent leaders enforce discipline throughout the belligerent parties? How do these factors affect the course of action (COA) of each belligerent? What are belligerent centers of gravity?"

Terrain dictates points of entry and infiltration and exfiltration routes. Commanders may use a terrain analysis to divide the AO, particularly urban areas, into zones of control using group, religion, or established TOR as determining factors. Analysts consider topography,

hydrology, and weather from both a current and historical perspective. They consider the effects of weather on mobility, trafficability, and visibility. The environment may also pose threats to the health of both mission and host nation personnel. Analysts should also identify corridors for reserve operations and contingency forces.

Evaluate the Threat. Analysts identify all factions involved in the peace operation. They recognize differences in the types of threats, strategies, *modi operandi*, and tactics, as well as weapons, equipment, materiel, and personnel. They add *personalities* to the usual list of order of battle factors; identify leaders, trainers, key staff members; and develop psychological profiles of key personnel. Analysts identify and analyze all threat battlefield operating systems and vulnerabilities

Determine Threat Courses of Action. This determination culminates analysis. Intelligence analysts determine COAs using the following steps:

- Step 1. Template or describe the actions of belligerents that would violate the peace. Initiating hostilities, breaking legal mandates, or disregarding established TOR are examples of violations. Develop course of action models depicting the response of belligerent to violations of the peace.
- Step 2. Develop course of action models depicting the reaction of all belligerents to friendly peace operations within the AO and AI.
- Step 3. Wargame each COA. Use friendly commanders and staffs to role-play both the friendly and belligerent parties to aid in determining the likelihood of various COA.
- Step 4. Analyze the reactions of the local populace to friendly COAs.
- Step 5. Analyze the reactions of the host nation government and military to friendly COAs.

Intelligence operators wargame terrorist actions and other activities that could jeopardize

the peace or friendly security and where belligerents could avoid claiming responsibility. Given the nature of these types of potential threats to US forces, it may be difficult to obtain much of this information without an interagency approach to the IPB process. The success of peace operations will increasingly depend on the combined efforts of numerous agencies.

Intelligence Collection and Synchronization Planning

Collection of intelligence in peace operations differs somewhat from collection of intelligence in conventional operations. Units should consider the use of the *dispersed battlefield* collection plan format. For detailed guidance on this format, refer to FM 34-2.³ In peace operations, belligerent parties may perceive intelligence gathering as a hostile act. Intelligence operations may therefore destroy the trust the parties should have in the peace operations force.

Intelligence Dissemination

LNOs should disseminate intelligence products in standard intelligence report format. LNOs should pass intelligence products to all parties requiring them in joint or multinational operations.

Intelligence for Multinational Peace Operations

In a multinational setting, forces will need to share intelligence information to some degree. This may involve sharing intelligence information with military forces of nations with which we have no intelligence-sharing agreements or sharing intelligence that is not covered by existing agreements. In some cases, we may have existing agreements that discriminate among allies within the multinational force. For example, our standardized exchange systems with NATO nations may create friction where we have NATO and non-NATO partners in a peace operation.

³ *Collection Management and Synchronization Planning*, 8 March 1994.

Situations may exist where intelligence should be shared with NGOs outside usual political-military channels. Therefore, these operations require policy and dissemination criteria and authority for each instance. At the outset, intelligence planners should establish a decompartmentation cell—provided by the Defense Intelligence Agency (DIA). Other special intelligence arrangements for multinational operations may include a single director of intelligence and combined intelligence centers.

LOGISTICS

As noted previously, CSS units may execute primary missions of the force. Regardless, logistics will be a key aspect of any peace operation. The complexity of such operations, especially in a joint and multinational environment where NGOs and PVOs are also involved, will produce unique demands on logistics operators and planners. Rapid force projection from platforms in CONUS or forward-presence bases, extended lines of communication, and potential forcible-entry operations into logistically bare-based areas of operations will require versatile and agile logistics leadership. Chapter 4 provides additional planning considerations.

PUBLIC AFFAIRS CONSIDERATIONS

Peace operations are carried out under the full glare of public scrutiny. Public affairs (PA) personnel support the commander by working to establish the conditions that lead to confidence in the Army and its conduct of peace operations. Because reports of peace operations are widely visible to national and international publics, PA is critical in peace operations. News media reports contribute to the legitimacy of an operation and the achievement of political, diplomatic goals. PA must monitor public perceptions and develop and disseminate clear messages.

PA planners support open, independent reporting and access to units and soldiers. PA personnel pursue a balanced, fair, and credible presentation of information that communicates the Army perspective through an expedited flow of complete, accurate, and timely information.

Commanders should ensure early coordination of PA, CA, and PSYOP efforts during the planning process. A continual exchange of information must exist during execution. Although each has a specific audience, information will overlap, making it crucial that messages are not in conflict. All members of the force should understand the following basic PA principles:

- Identifying, understanding, and fulfilling command information needs is critical to success. The uncertainty, unfamiliar conditions, and visibility of many peace operations requires that the information needs of soldiers be met. Soldiers must receive information specific to the operation through command channels and world, national, and local news. This enhances morale and unit esprit. It eases distractions and reduces the boredom, fear, isolation, uncertainty, rumor, and misinformation inherent in peace operations.
- Every soldier is a spokesperson. PA guidance should be widely disseminated. Although the commander is normally the unit's official spokesperson, informed junior soldiers, however, are also honest, accurate, forthright, and insightful spokespersons. The degree of media attention focused on a peace operation will lead to soldier-media interaction, and members of the media will seek soldier commentary.
- The media is an important information channel to the American public. In the high visibility, politically sensitive peace operation environment, public opinion is a critical element. By proactively assisting news media representatives, commanders help them understand the Army role in peace operations and produce stories that foster the confidence of the American public. Nevertheless commanders must balance OPSEC and other operational requirements with these needs.
- Following the principles of news coverage of DOD operations agreed upon by the media and the military is essential to accomplishing the PA mission. The public has a right to know about Army participation in peace operations, but more importantly, the Army

has a responsibility to keep the public informed. Voids in information supplied to the media by the military will be filled with hostile propaganda or media speculation. The extremely political nature of peace operations and the open and independent nature of reporting strongly support the principle of making information readily available within the constraints detailed by the source of authority.

LEGAL CONSIDERATIONS

Numerous legal issues may arise because of the unique nature of peace operations. Peace operations may be authorized by the UN, a regional organization, or the NCA. Regardless of who has authorized the peace operation, international law and US domestic laws and policy apply fully. For example, the laws of war and fiscal law and policy apply to US forces participating in the operation.

STATUS OF FORCES AGREEMENTS OR STATUS OF MISSION AGREEMENTS

In PK, the status of the PK force, as well as that of individual PK personnel in the host nation, is controlled by a status of forces agreement (SOFA) or a status of mission agreement (SOMA). In a UN operation, the UN negotiates the SOFA or SOMA. In the case of a non-UN operation, the US will negotiate an agreement with the host nation. In certain situations, the status of US forces may not be defined by a specific international agreement. Such was the case, in Somalia, where a functioning host government that could enter into a SOFA or SOMA did not exist. In typical PE, where the host nation does not necessarily consent to the US presence, a SOFA or SOMA usually is not practical. In such a case, as in Somalia, the US retains total jurisdiction over its forces. See Appendix A for additional information.

LAW OF WAR

Because of the special requirement in peace operations for legitimacy, care must be taken to scrupulously adhere to applicable rules of the

law of war. Regardless of the nature of the operation (PK or PE) and the nature of the conflict, US forces will comply with the relevant provisions of FM 27-10⁴ and DA Pamphlet 27-1.⁵ In a traditional PK operation, many uses of force may be addressed in the mandate or TOR. In a PE operation, the laws of war may fully apply.

CLAIMS AND LIABILITY

A significant aspect of legal activities in peace operations relates to claims and liability adjudication. In some instances the US may assume this role for the entire UN or multinational force, requiring extensive coordination, liaison, and accurate accounting.

FISCAL CONSIDERATIONS

Military commanders cannot spend operations and maintenance Army (OMA) funds on projects beyond the scope of their mission; nor can they authorize the expenditure of funds specifically appropriated for other purposes. They must be aware that well-meaning civil action

⁴. The Law of Land Warfare, July 1956.

⁵. *Treaties Governing Land Warfare*, 7 December 1956.

projects have significant funding limitations. If US forces participate as part of a UN operation, all costs should be captured for future reimbursement from the UN. Commanders should consult with their servicing judge advocate, supporting contracting officer, and comptroller.

Historical Perspective

In Operation Restore Hope, the US was not an occupying power, yet the law of occupation (Fourth Geneva Convention) was used as a model in defining US relationships with the civilian population. This law included obligations owed to the civilian population within the US AOs and rules regarding destruction, seizure, confiscation, and requisition of public and private property. Both the law of occupation and the law regarding the treatment of prisoners of war (Third Geneva Convention) provide useful guidance on proper disposition of the detainees.

CHAPTER 4

Logistics

Logisticians deal with unknowns. They attempt to eliminate unknowns, one by one, until they are confident that they have done away with the possibility of paralyzing surprises.

LTG William G. Pagonis
Commander, 22d Support Command (1992)

In peace operations, the US Army may find itself the principal provider of logistics support to a joint or multinational force. This chapter outlines aspects of logistics planning for peace operations. It includes specialized guidance for operating within the UN or other multinational logistics support environment, developing a local capability to provide support, and providing support to multinational forces as well as local nationals, NGOs, and PVOs.

LOGISTICS-PREPARATION OF-THE THEATER

Logistics-preparation-of-the-theater (LPT) is critical. LPT is a key tool available to logistics planners in building a flexible operational support plan. It consists of actions taken by logisticians to optimize means—force structure, resources, and strategic lift—of logistically supporting peace operations. These actions include identifying and preparing bases of operations; selecting and improving lines of communication (LOCs); projecting and preparing forward logistics bases; and forecasting and building operational stock assets forward and afloat. These actions focus on identifying the resources currently available in the theater for use by friendly forces and ensuring access to them. A detailed logistics estimate of requirements, tempered with LPT, allows the command logistician to advise leaders of the most effective method of providing support that will not overwhelm the force or fail to provide adequate, timely support. It involves the full range of logistics activities.

UN assessment teams are normally sent to a new mission site to provide UN leaders with

information to refine force size and composition, as well as logistical planning data for force deployment and sustainment. When participating in a UN mission, engineers and logisticians should plan to participate in the UN mission survey team in order to prepare the UN assessment. Logistics automation and communication personnel may assist in this UN effort. US efforts to participate and/or coordinate with UN forces will improve the unity of effort and reduce potential conflicts for facilities or resources. Several logistics considerations are critical in peace operations. Those that cross functional lines include training, security, and transition.

TRAINING

Logisticians must consider special training for peace operations. Logistics planners at all levels must have a basic understanding of logistics and support doctrine, procedures, and capabilities. They must understand the limitations of the nations participating in the mission. The ultimate goal is logistics support and sustainment of the total force (see Figure 4-1). Planners must consider ways of integrating logistics automation and foreign parts and supplies into existing automation.

Figure 4-1. Logistics Training

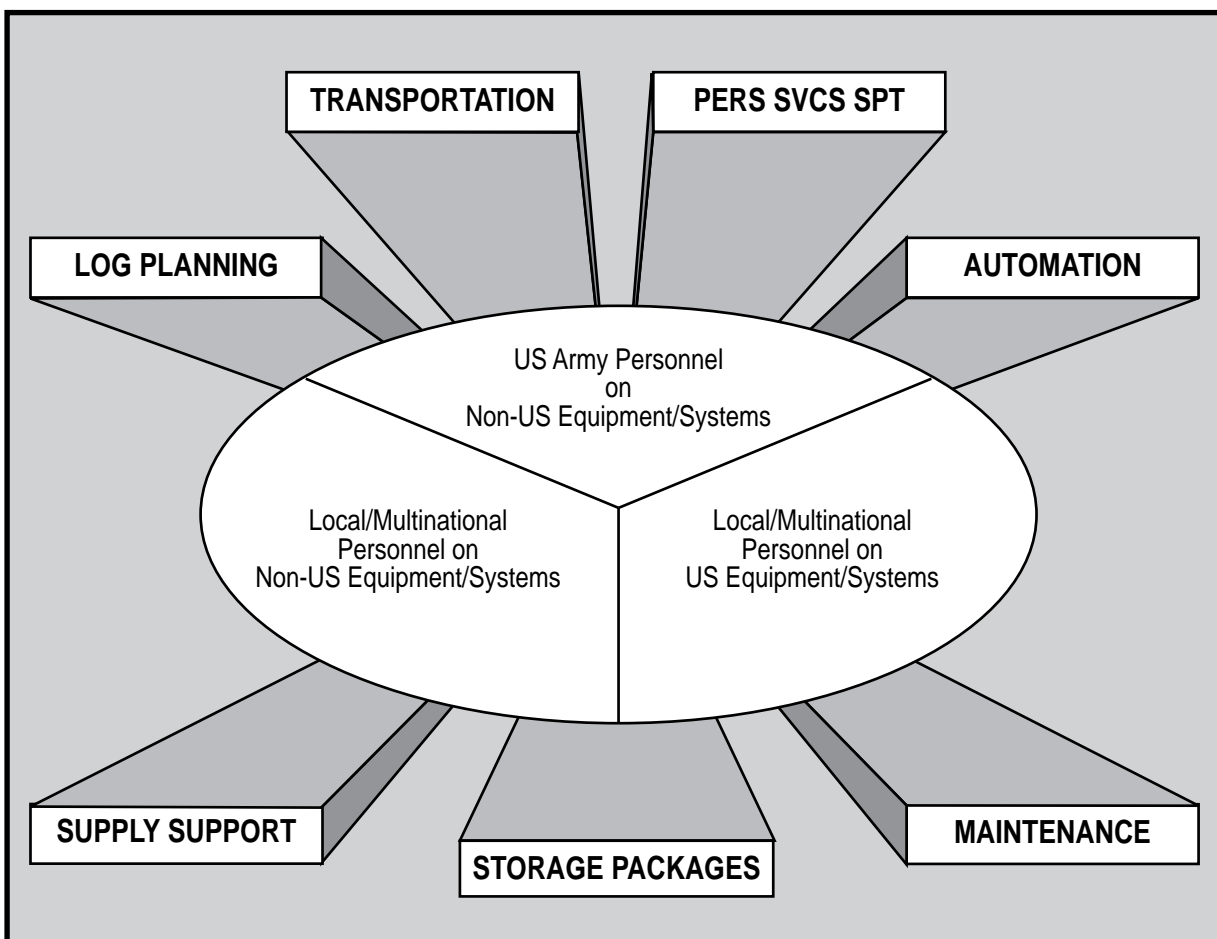

SECURITY

All CS and CSS units are responsible for providing their own security. This security mission may however, detract from the unit capability to provide logistics support. Security may be provided by another unit to ensure the unrestricted flow of logistics. The US Army Criminal Investigation Command (USACIC) provides advice on logistics security.

TRANSITION

Logisticians play a key role in planning transition of functions. Logistics functions performed by US Army elements may shift to—

- Another US service.
- An ally.
- The UN or a regional alliance or coalition.

- An NGO or PVO.
- Civilian authorities or contractors.

In other situations, the requirement for the function may end. In such a case, the transition must be planned in depth. Transfers of functions require careful coordination between the two parties. They must specifically agree on what functions are involved, when the transfer is to take place, whether any assets will accompany the transfer, the standard required for the support function, and any other items peculiar to a particular situation. The same factors apply when a US element takes responsibility for a function from another party. Army units accepting functions cannot assume that equipment and supplies on hand when they arrive will remain behind for their use.

SHARED LOGISTICS

Nations, forces and agencies coordinate and work toward a common goal without reservation. Logistics may be conducted unilaterally. In other cases, a US element may be part of a logistics operation of the UN, a regional alliance, or an *ad hoc* coalition.

The most efficient logistics operation is planned and operated by one country. However, such a situation may not always be feasible or acceptable; therefore, logistics is often a shared responsibility. Such cases require extensive planning and coordination to integrate various national logistics systems. Yet, even a logistics operation led by the US involves numerous complexities since other elements of the force are likely to be from other countries.

MULTINATIONAL OPERATIONS

Traditionally, the responsibility for logistics is a national responsibility. However, logistics support for a multinational operation must be the collective responsibility of the nations involved. The level of US participation in these operations is dependent on the objectives agreed upon at the national level.

The US logistician, as part of a multinational staff, will confront differences in terminology, procedures, cultural attitudes, and preferences related to all aspects of logistics. The multinational commanders or staffs may place demands on the system without understanding the capabilities and limitations of logistics elements. They may also require results not attainable through the logistics system or give directions that may conflict with established policies or procedures. Logisticians should use LNOs and have periodic coordination meetings to address these considerations.

Varying expectations of support from different elements of a multinational force provide another challenge during multinational operations. Nations must agree individually or through cooperative agreements to the provision of logistics resources or specific support requirements for their forces. Agreements may be worked out for specific operations where members of various contingents receive specific compensation such as cash bonuses, paid trips home,

shorter tours, or specific logistics support. Without specifically agreed-upon levels of support, contingents may have different expectations regarding support. Logisticians must know if available support assets meet not only US standards but also those of supported multinational forces. In the case of subsistence, for instance, the standards include both hygiene and cultural and religious requirements.

The chief logistics officers of the force must ensure that standardized logistics procedures are based on mutual understanding. All must use these procedures and understand status reporting so that the chief logistics officer and his staff know what assets are available. In UN operations, logisticians should pay particular attention to the *Guidelines for Contributing Nations*, published by the UN. Logisticians must communicate logistics priorities to the chief administrative officer (CAO) to ensure consistency with budget priorities. See Figure 4-2.

UNITED NATIONS OPERATIONS

UN operations present unique logistics challenges. However proactive coordination establishes effective logistics support and sustainment. Logistics policies and procedures for both the UN and participating nations should be tailored for the specific mission. Planning, coordination, and agreements among participating nations are essential. Also the effective use of contracting and control of funding is critical to eliminating unnecessary competition for limited resources.

The UN has only a small operational planning capability. A small staff of military officers from member nations assists the UN's military advisor in logistics planning. Support plans are typically developed for each operation. One of the most important planning aspects for each operation is to clearly affix logistics support responsibilities. Each contributing nation has some responsibility for providing logistical support to its own forces. Funding for UN operations is only approved after establishment of a force and only for the period of the mandate of the operation. Support techniques that may be efficient and effective for a lengthy operation may not be feasible if planners cannot count on funding past a short-term mandate period.

Figure 4-2. Multinational Logistics Operations

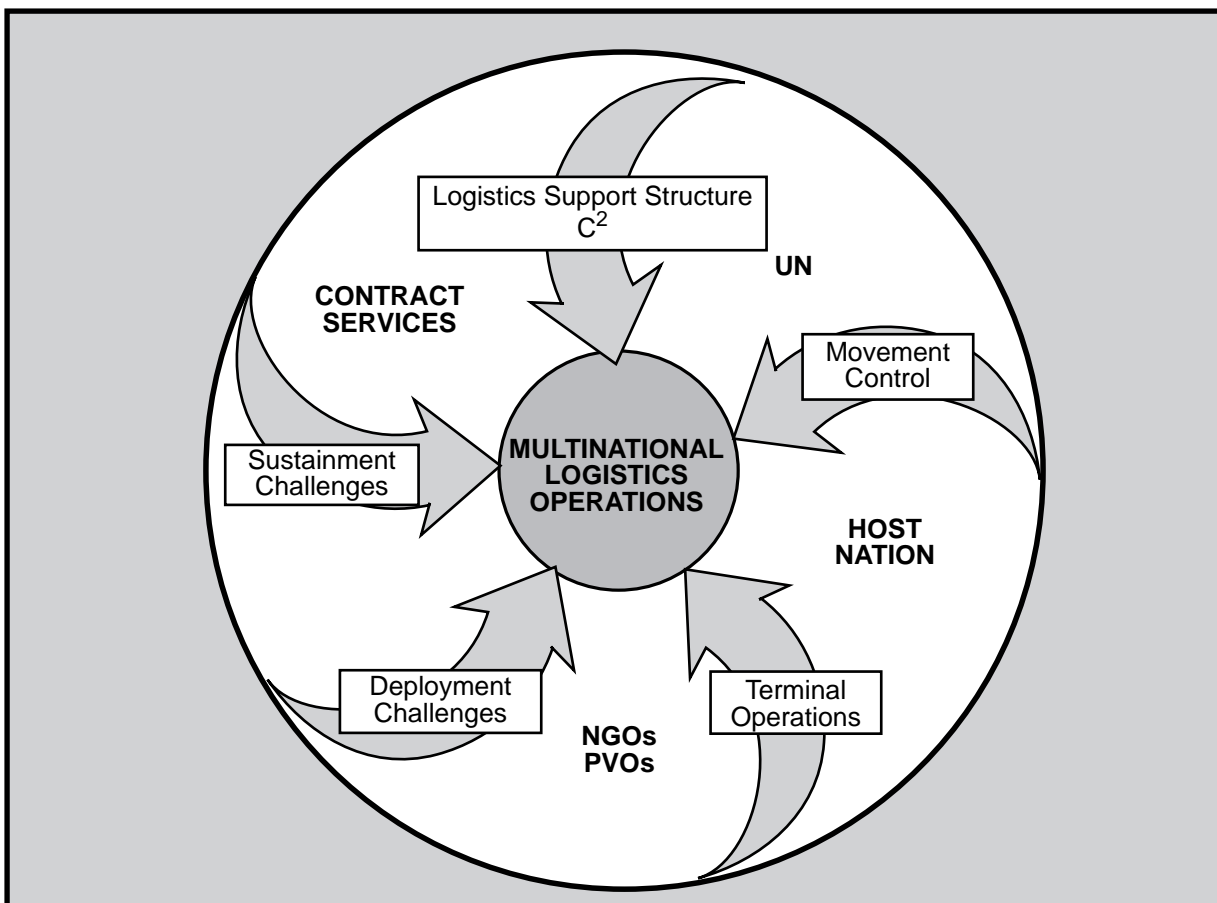

Finally, the nature of a peace operation is frequently fluid in terms of tactics and sometimes even strategies. As a result, logisticians who are used to time-driven schedules may have to adjust to working in event-driven situations.

The UN uses an expanded definition for the term *logistics*. The UN definition includes engineering, communications, and aviation support. UN headquarters, force headquarters, and contingents all deal with logistics. All must understand the UN logistics system.

United Nations Headquarters

The UN headquarters element that has the most responsibility for support to a UN-sponsored force is the field administration and logistics division (FALD) of the department of peacekeeping operations (DPKO). Its responsibilities include—

- Planning the support structure.
- Selecting key civilians for the operation.

- Coordinating contributions from member states.
- Prioritizing requirements from the force.
- Negotiating local purchase agreements with host nations.
- Negotiating for transportation to the theater.

The FALD develops its support plan around one of three possible methods.

- One option is to have one nation control all the logistics for an operation. Though this is usually the most efficient option, it is not always acceptable, nor is one nation always capable or willing to perform this role.
- The second option is to make logistics a shared responsibility, both in terms of logistics elements deployed and logistics personnel on the force headquarters staff.
- The final option is to decentralize logistics planning and operations if the operation is dispersed over wide areas in different regions.



Planning, coordination, and agreement among participating nations is critical to UN logistics operations.

Force Headquarters

For the deployed force, the key logistics officers are the CAO and the chief logistics officer (CLO). The CAO has overall control of support to the operation, while the CLO controls the day-to-day logistics functions. Effective support to the force requires that these two officers work closely together.

The FALD appoints the CAO. The CAO may not be appointed for operations that are limited to a strictly observation mission. The CAO acts under the authority of the chief of mission, who is normally a special representative of the SYG. He retains a direct link to the UN headquarters. Within the AO, he is responsible for local purchases, host nation support, financial arrangements, prioritizing lift, and passing requirements to the FALD at the UN headquarters. If logistics operations are to be handled on a decentralized, regional basis, a CAO may be appointed for each region. CAO funding authority is limited. The CAO manages the entire mission budget.

The CLO is a military staff officer on the force headquarters staff. He is responsible for establishing and

operating the logistics base, often called the field maintenance area. He uses a series of UN directives to control operations and ensures all contingents understand the logistics policies and procedures. The CLO validates all logistics requirements and passes them to the CAO for funding and procurement. The CLO also controls the activities of the logistics elements in the logistics base. Typically those elements provided by each contingent are organized into a force logistics support group (FLSG).

The FLSG coordinates receipt of stocks and movement to forward bases, as well as the sustainment of the force. The FLSG headquarters, under control of the CLO, coordinates support to contingents and keeps the force headquarters apprised of the logistics situation. The FLSG headquarters includes staff elements called national support cells from each contingent. These cells oversee support to their contingents and serve as liaison elements to coordinate with other contingent cells. The logistics activities provided by the FLSG include the full range of logistics support.

Figure 4-3. NATO Logistics Principles

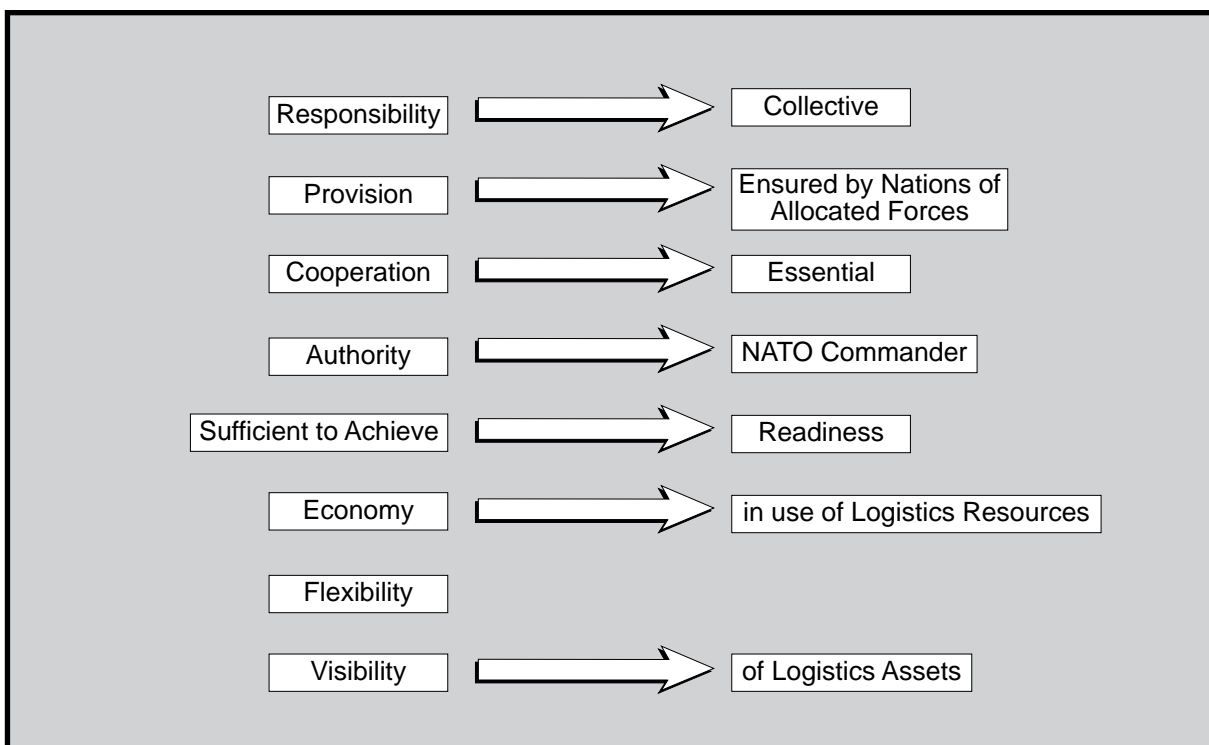

The base also includes maintenance shops and facilities for other required services such as postal or operations. The UN provides any required unique items such as UN berets, field caps, hat bands, scarves, and cloth shoulder pads. Also, the FALD provides contingents with supply planning factors.

Contingents

For each participating nation, logistics planning is similar to planning for any other multinational operation, except it receives support from a UN-operated base. Each contingent provides a national support element (NSE) to the FLSG. The NSE is a logistics operations element incorporated into the FLSG to meet the requirements of its contingent.

Some contingents may be self-supporting, while others rely on cooperative resources and bilateral agreements. Each operation is different. The UN negotiates the level of stocks the participating nations must bring. However, planners

should anticipate a requirement to build a self-sufficient contingent force for the early stages of the operation.

The UN typically requests national contingents to arrive with personal weapons and ammunition, organic transportation, unit radios, organic maintenance and medical assets, and an agreed-upon stockage level of all supplies for 30 to 90 days. Despite such requests, units may arrive with little more than rifles and rucksacks. In such cases, the UN seeks donations of equipment from member nations, buys new equipment, or attempts to procure equipment on the local market. The UN's member nations have agreed to establish stockpiles of essential supplies and equipment. This effort will speed UN's operational response time.

NATO Operations

When called upon to reinforce peace operations using NATO forces, planners must be aware of NATO requirements and procedures. Nations and NATO authorities have a collective responsibility for logistics support of NATO's

multinational operations. Although each nation bears ultimate responsibility for ensuring the provision of logistics support for its forces allocated to NATO, the NATO commander establishes the logistics requirements and coordinates logistics support within his AO. While nations have first call on their logistics resources, NATO commanders may direct the redistribution of logistics resources to meet critical operational needs. The principles in Figure 4-3 emphasize logistics support responsibilities during NATO operations. NATO logistics doctrine is addressed in greater detail in MC-319,¹ MC-326,² and MCM-CIJ-001-94³.

RESOURCE MANAGEMENT

The UN will reimburse contributing countries for the costs of the operations in accordance with its standard procedures as covered in the UN guidelines to contributing governments, aides-memoir to the peacekeeping agreement, notes verbal, and specific and general letters of assist (LOA).

If possible, the UN must approve all elements of national contributions and the extent of reimbursement prior to the actual deployment. Therefore, costs incurred for activities and troop deployments that are not agreed to by the UN will not normally be reimbursed by the UN. The CAO determines the obligatory authority in a particular operation.

US logisticians should track items that the UN agrees to reimburse. The CAO or his designated representative verify delivery of supplies or services. UN reimbursement is contingent on validation of requirements prior to obligation of funds and verification that supplies and services were rendered. Bills are generated for reimbursable items and sent through channels to the UN (see Figure 4-4).

¹ NATO Principles and Policies for Logistics.

² *Medical Support Precepts and Guidance for NATO*.

³ *NATO Commander's Authority Over Logistics Resources*, [Annex A to MC-319].

Logistics assistance during peace operations may be furnished under a variety of statutes:

- For ongoing UN operations, much of the support is provided under Section 552 of the *Foreign Assistance Act (FAA)*, Title 22.
- In other cases, support involving NATO countries may be covered by NATO agreements.
- The President may direct an emergency drawdown of military department inventory stocks under Section 506 of the FAA for emergency assistance programs or support or under Section 552 of the FAA for PK.
- In an emergency drawdown, all materiel, services, and training must be drawn from existing service stocks. This emergency authority does not authorize new procurement or expenditure of service funds.
- Support may be provided to other countries and to the UN under FAA, Section 607, Sales or Grant Transfers, or with reciprocal services or replacement-in-kind under Title 10, Chapter 138, with Secretary of State approval.
- Logistics support authorized under Chapter 138 includes food, billeting, petroleum, oils, transportation, nondistinctive clothing, communications services, medical services, ammunition, storage, spare parts, repair and maintenance services, and training. Unlike security assistance transfers under the FAA, however, logistics support authorized under Title 10, Chapter 138 does not include major end items, missiles, or bombs.
- The service judge advocate will answer questions concerning fiscal issues associated with the provision of statutory logistics support.

LOGISTICS FUNCTIONS

The LSE is the forward element of the national strategic logistics base and may perform any and all supply, maintenance, readiness, and other logistical functions. Its traditional role is to support Army forces. However, by augmenting its normal role, it is also uniquely structured to support multinational land forces. The LSE can establish and operate a humanitarian depot in

Figure 4-4. UN Reimbursement to the US

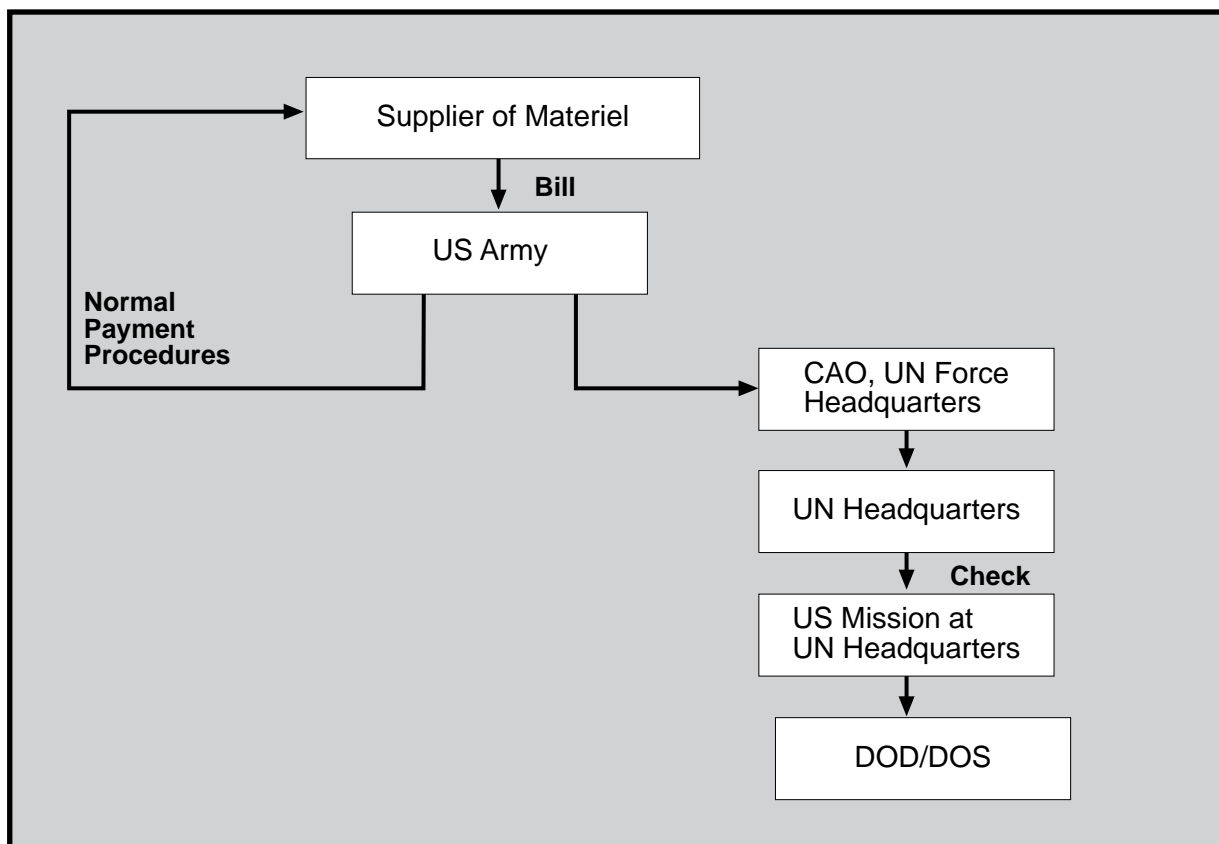

coordination with local authorities, multinational partners, and nongovernment agencies. The LSE must augment its organic capability to maintain non-US weapon systems. The following logistics functions are key to peace operations.

MOVING

Early deployment of transportation planners, a port-opening package, and movement control staff are critical. In underdeveloped countries, the logistician must plan to conduct transportation and movements control in adjacent and/or supporting countries to ensure expeditious resupply to the.

Movement Control

In a UN-controlled or multinational environment, participating nations share use of the same LOCs (air, sea, ports), requiring prioritization

and deconfliction of the use of LOCs. The commander may establish a multinational movements control center (MCC) at the UN level to resolve disputes, allocate resources, and integrate transportation efforts. If US forces provide a majority of inland movement assets, the US may be required to provide a US movement control element to form the nucleus of the MCC or to provide representatives if another nation has the mission. The senior US movement control organization must ensure US requirements are adequately articulated and integrated into multinational plans.

Port Authority

A military or civilian port authority integrates seaport operations; discharges US, multinational, and civilian vessels; and manages real estate in the port and adjacent areas. In the absence of a recognized government or civilian authority, planners must select the appropriate headquarters to perform this mission.

Augmentees to a civilian or multinational port authority staff may be required. These may include a diplomatic officer (DOS), a political officer, a judge advocate officer (with knowledge of maritime law), a military translator, a LNO for contract supervision, and a CA team.

Inland Movement

Planning for inland movement must ensure that adequate transportation assets, materiel, and cargo handling equipment are provided. Types of units provided are based on the mission, terrain, and route characteristics.

FIXING

Maintenance elements should be prepared to support civilian assets as well as those of other military forces in peace operations. Also, the UN may purchase US equipment to outfit other multinational forces. In such cases, those forces may not have the capability to repair or perform preventive maintenance on the equipment. US units may be called on to provide support or at least identify total support packages that include tools, repair parts, test equipment, and training. National-level agreements determine the extent of maintenance support of other nations' equipment.

The end state may require that maintenance support for peace operations include reestablishing and/or upgrading the infrastructure maintenance capabilities. This may entail providing tools and equipment to multinational and local forces. Careful property accountability is important. Non-US personnel at the user level may also require training in maintenance and supply automation

SUSTAINING SOLDIERS AND THEIR SYSTEMS

Unique aspects of peace operations in a multinational context include the need for compatibility of automated systems among direct-support, materiel management, and financial management organizations. Additionally, LPT and a greater reliance on UN support and local and contingency contracting to provide supplies may release valuable

strategic lift for both supplies and CSS units.

When possible, it may be more efficient to assign a single supply support responsibility to one nation. Another unique aspect of multinational operations is that non-US forces are generally not authorized to use the Army and Air Force Exchange System (AAFES) or other exchange facilities. This may generate misunderstandings and expectations of support that need to be addressed. Under some circumstances, the commander can authorize the limited use of exchange facilities by foreign military forces operating with US forces. However, the commander must carefully consider the ramifications of such a decision.

Field Service Support

Predetermined agreements aid in providing economy of force. Field service support personnel must respect the social mores, customs, and standards of health and welfare of the locality, as well as the peace operation participants. Logisticians should use available services in the AO or those provided by other forces to reduce the required force structure.

Health Service Support

Planners for peace operations must consider all health service support (HSS) systems. In determining requirements for assets, they must consider the impact of providing medical care to multinational forces or local populations. Peace operations result in more frequent and direct contact with the local population. Provision for the mix of care-provider skills, instrument sizes, drugs, and supplies to support pediatric, geriatric, and obstetric problems requires prior planning for mission support. The US can project power from forward presence locations in response to requirements from the NCA. Because of this presence, medical units of the medical command (MEDCOM) and/or corps support command (COSCOM) are among the initial medical forces available outside the continental United States (OCONUS).

Personnel Services

In peace operations the personnel system may need to account for joint, multinational, or local personnel. Maintaining accurate strength accounting may be more demanding due to unusual tailoring of units to fit the particular peace operation mission. Strength reporting according to the UN format is required for reimbursement by the UN. Personnel units may assist local civilian authorities in personnel identification, classification, and accounting. Personnel units may assist in receiving and interviewing civilians to collect information and to identify individual skills that may be useful in the conduct of the operation. Personnel units may account for civilian casualties.

Religious Support

Peace operations require a diverse religious support capability. Without augmentation, each commander must share religious support assets to form a religious support system with diverse cultural and religious capabilities.

Band Support

Bands fulfill a variety of music roles to include military support to diplomacy, PA, CA, civil-military operations, PSYOP, and HA.

Finance Operations

Finance elements should deploy early to support procurement efforts and to begin the accounting process for peace operations. They also interpret, coordinate, and disseminate financial guidance to the commander.

Additionally, finance support ensures that soldiers' pay accounts reflect all entitlements associated with their peace operations duties. The deployed finance elements provide limited check-cashing support to soldiers and DOD civilians. Operational policies and may impose restrictions on cash payments to soldiers and limitations on currency and the value of goods removed from the country. Finance elements may be required to certify that such currency is a reasonable remainder of pay received in that country.

Historical Perspective¹

Operation Able Sentry, a UN preventive deployment mission in the former Yugoslav Republic of Macedonia, provides some insight into the positive impact of chaplains in this environment. In this part of the world, diverse religions clearly play a significant role in the daily lives of the population. Religion captures the spotlight in the national political arena as well.

In FYROM, for example, 60 percent of the population is Greek Orthodox, 25 percent is Muslim, and 2 percent is Roman Catholic. The remainder is splintered among a variety of religions and sects. A task force chaplain's interaction with the Macedonian Roman Catholic bishop and local Greek Orthodox priests proved significant in convincing the religious leaders to view the UN mission positively. The calming effect resulting from "telling the UN/US story" proved significant in enhancing both force protection (citizens now view the UN positively) and the overall mission.

¹. Adapted from a Center for Army Lessons Learned "News From the Front."

Historical Perspective

In the first 30 days, finance support touched more than one-third of the Army force deployed and was directly responsible for providing Army units the capability of employing more than 120 local citizens, freeing that number or more soldiers for the direct support of Operation Restore Hope.

33d Finance Battalion After-Action Report

Finance elements may provide for currency support, including currency exchange. Finance may provide payments for weapons turned in (weapons for cash), other bounties and claims, and other special programs. They may provide disbursing support to properly credentialed civilians (media, Red Cross), and civilian contractors. They may also pay travel and per diem for temporary duty during the operation.

Contracting Support

For UN operations, contracting support includes accounting for support provided to US forces through UN forces contracting and disbursing and arranging for reimbursement. Commercial vendor services (CVS) support covers the immediate needs of the force that cannot be reasonably met by normal logistics. CVS payments are usually paid by imprest fund cashiers, or Class A agents. These cash payments cover such expenses as day laborer wages and small quantities of supplies and services.

Some operations may require the creation of joint or multinational contracting elements, staffed by personnel from all services and contingents operating in the theater. Joint contracting organizations promote cooperation and coordination among the service elements and preclude interservice competition for local supplies and services to more effectively use scarce resources. In UN operations, contracting operations should

be coordinated with the UN chief procurement officer. A budget officer should also be involved in early planning.

Legal Services

Peace operations present many unique legal service support issues that may not be present in other types of operations. The legal services support package must meet the traditional legal assistance, military justice, administrative and civil law (including contract and fiscal law advice), and operational and international law needs of the deploying force. The package must also be tailored to the particular peace operation. Additional peace operations planning considerations for legal services may include, but are not limited to—

- Staffing a multinational task force law office designed to support the operations of many nations and/or the UN.
- Coordinating the efforts of attorneys from many nations, ensuring quality and consistency of advice.
- Having foreign claims authority and sufficient assets to investigate and adjudicate claims.
- Adjudicating conflict of law issues when no government or legal system or procedures for reestablishing a government or legal system exists.
- Assisting with legal issues when dealing with NGOs and PVOs.

APPENDIX A

The United Nations

A new chapter in the history of the United Nations has begun.

Boutros Boutros-Ghali
UN Secretary General

The Peacekeepers' Handbook and other references explain in extensive detail the organization and functions of the UN during peace operations. This appendix does not provide an extensive description of the UN, but rather a general description of its organization and functions, the legal aspects of its operations, extracts of the UN charter, a sample mandate, and TOR.

ORGANIZATION

The UN has, as its primary responsibility, the maintenance of international peace and security. The charter provides the basis for the various elements of the UN in fulfilling this responsibility.

SECURITY COUNCIL

The United Nations Security Council (UNSC) is vested with the authority from the UN Charter to investigate any situation or conflict that threatens international peace and security. It usually tasks the secretary general (SYG) to prepare a plan to deal with the crisis and is the approving authority for that plan. The UNSC may either decide to take action or refer the matter to the United Nations General Assembly (UNGA) for consideration. The council's decisions are theoretically binding on all member states of the UN.

SECRETARY GENERAL

The UN SYG is responsible to the UNSC for the organization, conduct, and direction of UN peacekeeping operations. The office is, in effect, the commander-in-chief responsible for



The UN has as its primary responsibility the maintenance of international peace and security. US forces may participate as part of a UN force.

conducting negotiations with the host nations, belligerents, and contributing states; preparing the operational plan; and presenting it to the UNSC for approval.

GENERAL ASSEMBLY

The UNGA may consider any matter referred to it by the UNSC or may consider any other situation or conflict it feels impairs the general welfare or friendly relations among nations. The recommendations of the UNGA are not binding on the SYG, the UNSC, or its own members. Its powers in conflict resolution are not well-defined.

MILITARY STAFF COMMITTEE

The MSC was originally designed to advise and assist the UNSC and the SYG on matters of military concern. It is composed of the chiefs of staff of the permanent representatives of the UNSC or their representatives. Although envisioned as an international joint staff, to plan, organize, and command UN peacekeeping operations, various factors precluded its development in that direction. From time to time, a

military advisor or assistant has been appointed to advise and assist the SYG on military matters.

SECRETARIAT

The UN Secretariat is headed by the SYG and is the permanent organization responsible for the establishment, coordination, and administration of peacekeeping operations. Several secretariat departments headed by under secretary generals (USYGs) are involved in peace operations and may interface directly with the SYG's special representative to a specific peace operation. See Figure A-1.

The USYGs are responsible to the SYG for policy concerns with respect to peace operations. The Department of Peacekeeping Operations is headed by a USYG who is responsible to the SYG for the day-to-day operational matters affecting peace operations. Under the USYG for Peacekeeping is the military advisor to the SYG as well as the Director, Field Administration and Logistics Division, who is responsible for logistical support of peace operations. See Figure A-2.

Figure A-1. United Nations Secretariat

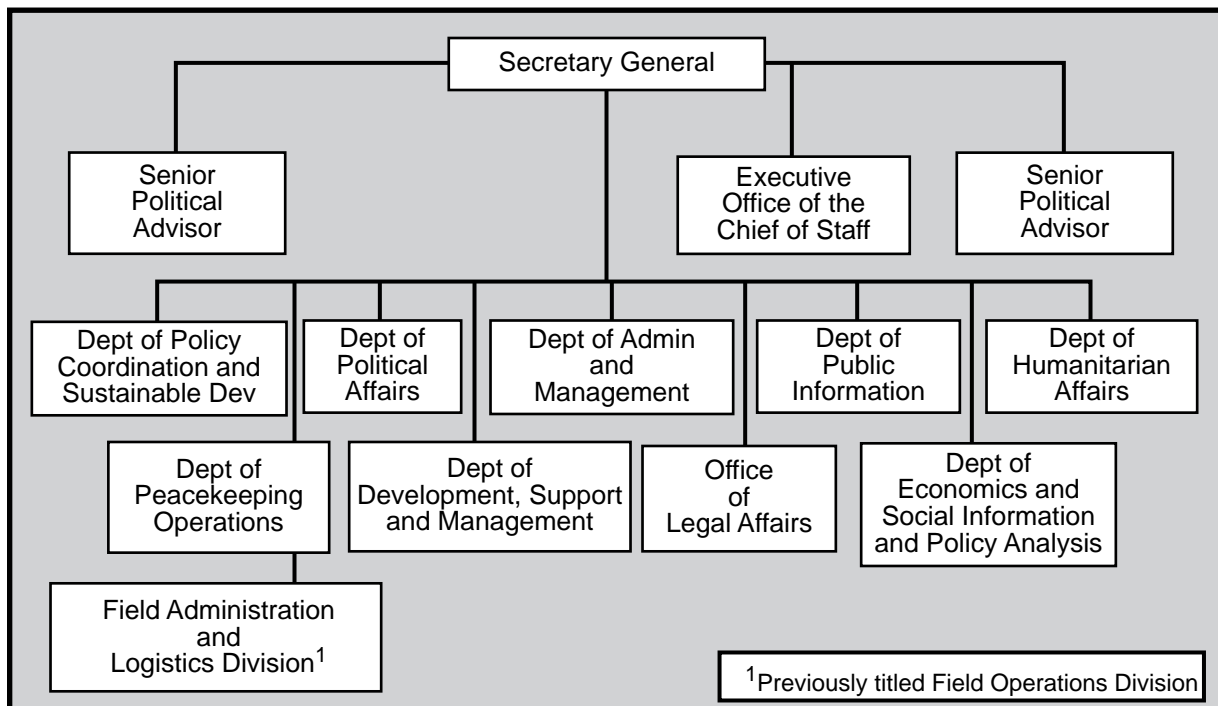

The Department of Administration and Management is headed by a USYG who is responsible to the SYG for the administration and financial support of peacekeeping operations.

The Department of Humanitarian Affairs is headed by a USYG who may also provide guidance to the SYG's special representative with respect to the humanitarian aspects of a specific peace operation and the peace operation's interface with PVOs and NGOs.

The Department of Political Affairs is the political arm of the SYG in matters relating to the maintenance of international peace and security and the control and resolution of conflicts within states. As such, it advises on policy in those areas and is responsible for political research and analysis. It also has executive responsibilities in the fields of preventive diplomacy and peacemaking, including negotiations and other diplomatic

activities. All these functions and responsibilities as they relate to field operations are prepared and carried out by the department under the overall direction of the SYG.

The Department of Peacekeeping Operations is the operational arm of the SYG for the day-to-day management of peacekeeping operations. In this capacity, the department acts as the main channel of communication between United Nations headquarters and the field. However, the Department of Political Affairs (on strictly political matters), the Department of Humanitarian Affairs (on humanitarian policy matters), and the Department of Administration and Management are also in regular contact with the field (see Figure A-2).

The Department of Humanitarian Affairs is responsible for the coordination of humanitarian operations, particularly for making the necessary

Figure A-2. Department of Peacekeeping Operations

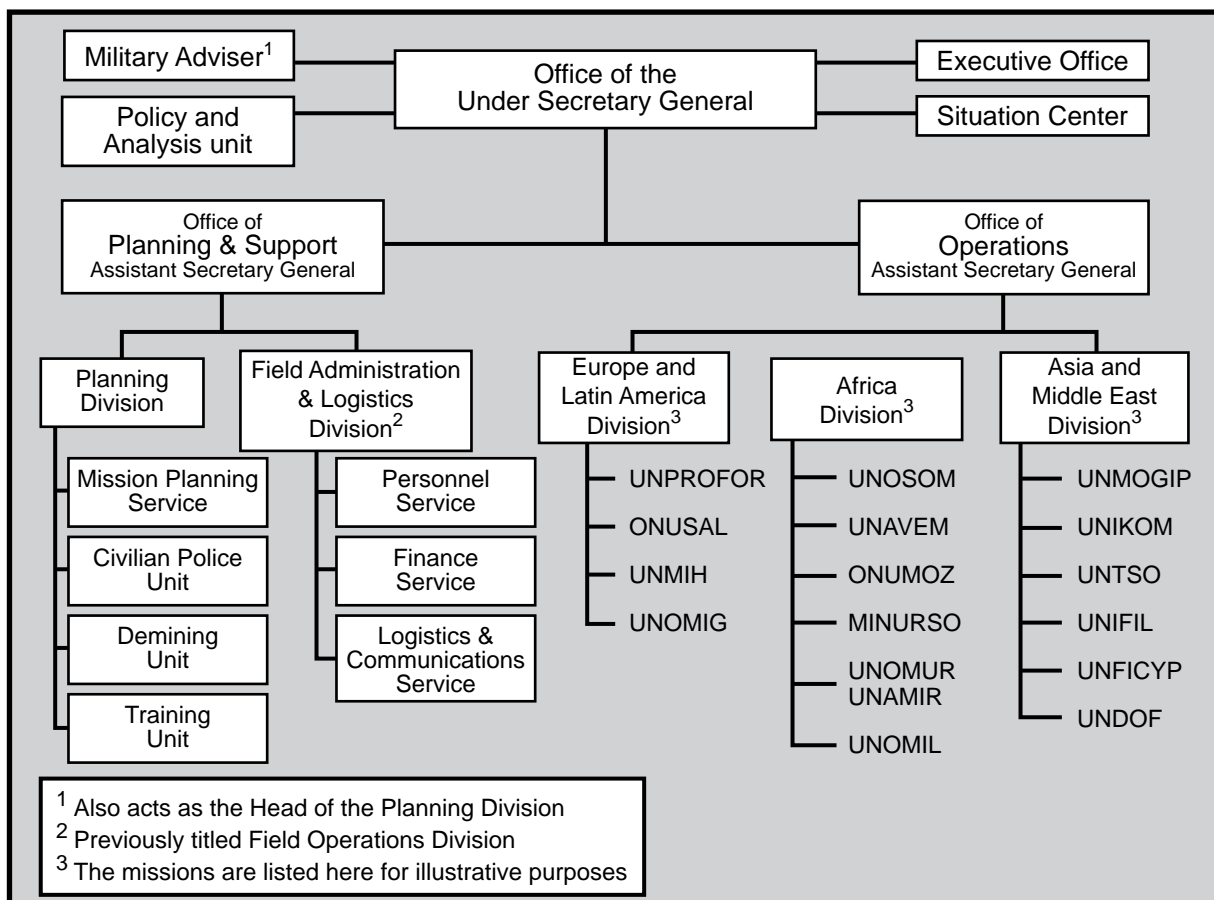

arrangements for the timely and effective delivery of assistance by United Nations relief organizations. As the focal point of the SYG for Humanitarian Assistance, its responsibilities also include early warning and negotiations for access to populations in need. In most recent complex operations, the department has appointed a field-based humanitarian coordinator who works under the authority of the special representative of the secretary general (SRSG) and is in direct contact with the Department of Humanitarian Affairs. In some cases, the humanitarian coordinator is with an agency or program, while in others, he is independent.

FIELD ADMINISTRATION AND LOGISTICS DIVISION

Each UN peace operation will have a UN official on staff. This official commands the deployed elements of the FALD and is responsible for all matters related to the operation. The official is usually a career UN civil servant. The FALD, in coordination with selected military staff officers, is also responsible for negotiating the SOFA, receiving and dispatching UN personnel, and establishing administrative and logistic standing operating procedures (SOPs). See Figure A-2.

PLANNING PROCESS

While no formal planning process exists for UN peacekeeping operations, the planning unit in the Department of Peacekeeping Operations is responsible for developing plans for approved operations. Each operation is unique and individually authorized, planned, and controlled. Instead of a universal checklist, a general pattern, based on past experience, is used for UN planning. The planning process of other international or regional organizations should parallel this sequence.

SITUATION ANALYSIS

At the outbreak of a conflict, the UNSC or UNGA should perceive a threat to international peace and security. The situation may be debated, and if a permanent member of the UNSC does not use its veto, a resolution may be passed.

SECURITY COUNCIL RESOLUTIONS

A UNSC resolution usually calls for a cease-fire or other measures designed to resolve conflict and may appoint a special representative, ambassador, or mediator to be sent to the conflict area to report on the crisis. The resolution may require the SYG to prepare a plan to deal with the conflict by creating a peace operation. The SYG is then responsible for informal negotiations and the preparation of a mandate. Mandates are typically for a 6-month period and must be renewed by the UNSC twice per year.

INFORMAL PREPARATIONS

Based on the direction the SYG receives from the UNSC, informal negotiations commence. This involves negotiations with member states to establish the tentative contributions (personnel, financial, logistical) that can be provided to a UN force. The requirements, balanced with the scale of contribution, determine the general composition and organization of the force. The SYG approaches the belligerent parties and drafts a mutually acceptable and enforceable mandate that is also acceptable to contributing members. The final product of these negotiations should be a viable mandate. The role, mission, and tasks of the operation derive from this mandate.

MANDATE

The SYG submits a plan for the peacekeeping operation and a proposed mandate for approval by the UNSC. If the council approves the plan and the mandate, the SYG commences formal preparations. The mandate provides the international legal authority for the operation. A second and equally important document is the budget plan that must be accepted to ensure that the operation can be funded.

FORMAL PREPARATIONS

With the approval of the mandate and the budget, the SYG ensures negotiations commence with the belligerent parties and the host nation for preparation of the SOFA. The SYG selects the key appointments for the force:

- The force commander—who is a military officer from a nation not involved in the conflict
- The UN political advisor—often called the SRSG—who is normally a career diplomat.

These appointments are usually agreed to by the belligerent parties in peacekeeping operations prior to the formal announcement to the media. Either the force commander or the SRSG may be appointed as head of mission.

The SYG verbally requests military forces and equipment from the contributing members. The requests at this stage are still general in nature, allowing some flexibility to contributing members until the exact scale of the force and international composition is determined. Once the UN has an acceptable force composition, it issues formal requests for troops and equipment services in the form of verbal notes or LOAs.

PARTICIPATING MEMBER-STATE PREPARATIONS

Participating member states negotiate the extent of their contribution to the operation with the UN and the host nation. Results will be incorporated into memorandums of understanding to secure those services or support from the host nation that are not provided by the UN. It is not unusual for the UN to place limits on national contributions due to nonmilitary factors such as financial limitations. The UN should finalize the SOFA or SOMA with the host nation before the force deploys. Until the SOFA or SOMA is finalized, soldiers are subject to the local laws or granted diplomatic status.

RECEPTION AND SERVICE SUPPORT

FALD usually deploys an advance party to establish reception and service support arrangements for the operation. The UN plans, organizes, and directs the deployment of the force to the theater. National contingents conduct training and prepare administrative materials required for deployment to the operation. National reconnaissance may not be allowed prior to deployment.

END SURVEY

The key action at the start of operations with the UN is the conduct of the *end survey*. The UN command performs the end survey after the national force arrives. The survey is the UN military staff identification of equipment, supplies, and personnel that the member country has deployed in support of the mission. Based on

that survey, the UN command can identify member nation capabilities and items it must support or reimburse for costs associated with operational use. The UN normally pays for equipment deployment and the costs to maintain equipment for operational use. The UN normally also pays for personnel rotations twice annually, usually on a six-month basis.

TERMS OF REFERENCE

The TOR (used in Somalia and FYROM) is an important document in UN operations. The TOR is the document developed by DOS with DOD that explains national responsibilities for each nation involved in a UN operation. The TOR is the planning document that impacts force structure, sets the stage upon deployment for the end survey, and provides the mission for the US force deployed for a UN operation. The TOR also addresses resource management and cost reimbursement. Detailed planning at the conception stage of involvement in UN operations during the development of the TOR eases cost impacts on national forces, since planners have already agreed on those subjects with the UN. US participants in the TOR development process are generally DOS and DOD. Force planners working with the UN should understand that if a US force is not tasked in the TOR—and the US deploys one—the UN will not provide resources or reimburse support to that force. See Annex A to this appendix for an example of TOR.

DEPLOYMENT

Deployment is usually a UN responsibility. It may be delegated to nations that possess a self-deployment capability. In the absence of this capability, a third nation such as the US may be used, under UN arrangements, to assist in deployment of national contingents. Upon arrival in the AO, the national contingents are normally placed under OPCON of the force commander.

OPERATIONAL CONTROL

The normal operational chain of command for peacekeeping operations is from the unit commander, to the force commander, to the head of mission; if not to the force commander, to the SYG, who reports to the UNSC. In certain cases,

US forces may be placed under OPCON of a foreign commander, but command is exercised only in the US chain to the NCA.

LEGAL ASPECTS

The legal authority under which a UN peace operation is conducted defines the parameters of the operation. The duties, responsibilities, powers, privileges, and immunities of a force and its personnel are laid out in international agreements and other documents. All commanders, observers, and officers in a peacekeeping operation must know the legal authority that regulates their operation. The key legal authority documents are—

- The mandate.
- The SOFAs, SOMAs, or other applicable agreements
- Applicable US directives and regulations.

THE MANDATE

The two types of mandates include United Nations mandates and non-United Nations mandates.

United Nations Mandates

The UNSC or UNGA resolution authorizing and defining a peace operation is referred to as the *mandate*. The mandate is the authority under which an operation is conducted. It may be subject to periodic renewal. Annex B to this appendix is an example of a UN mandate resolution.

The mandate is usually prepared in a climate of crisis. Its preparation involves a great deal of diplomatic negotiation and compromise. Political expediency usually takes priority over military operational requirements. The mandate is therefore a document of compromise. However, it must remain acceptable to the belligerent parties involved and the nations providing the peace operation force.

As a general rule, the clearer and more detailed the mandate, the more enforceable it is. Ideally, it should be flexible enough for peace operations forces to have freedom of action and movement. Once agreed upon, it is unlikely the mandate will change. Historically, there has been a general reluctance to reopen negotiations to

change a mandate. The mandate usually includes—

- The role of the peace operation force.
- The mission of the peace operation organization.
- The tasks or functions to be performed.
- The size and organization of the force or mission.
- The appointment of the commander, any special mediators, and their TOR.
- The nomination of the office responsible for the supervision of the operation.
- General arrangements for financial and logistical support.
- The division of UN and national responsibilities.
- The time limit of the mandate.
- The terms or conditions the host nation intends to impose on the presence of the force or mission.
- Statements of the rights and immunities of force or mission members.

Non-United Nations Mandates

Non-UN mandates usually result from treaties, accords, resolutions, or agreements evolving from other international or regional organizations. The aim of these is the same as a UN mandate, namely to create a peace operation force or mission to resolve a conflict. The contents of a non-UN mandate should be the same as a UN mandate.

STATUS OF FORCES AGREEMENTS OR STATUS OF MISSION AGREEMENTS

The second key document that defines the legal authority and responsibilities of a force and force personnel participation in a peace operation is the SOFA or SOMA. The SOFA or SOMA may be a treaty or a memorandum of understanding. It is an agreement negotiated between the UN and the host countries, which details the rights privileges, immunities, and nature of services to be provided to the force and its personnel, as well as their responsibilities and obligations.

Participating member states provide input to the UN secretariat on details in the SOFA or SOMA, but the secretariat and the host nation may, however, negotiate the agreement. Individual states may negotiate a memorandum of understanding with the host nation concerning specific items not covered in the SOFA or SOMA. SOFAs or SOMAs are rarely amended. Moreover, unlike a mandate, a SOFA or SOMA does not require renewal because it is a standing agreement.

Each SOFA or SOMA is different. Subjects that may be covered include—

- Control and authority over force areas and premises.
- Displaying of flags, banners, symbols, and so forth.
- Wearing of uniforms.
- Authority to carry weapons.
- Freedom of movement in the AO.
- Freedom of peacekeeping action in the AO.
- Identification of personnel, vehicles, buildings, positions, and so forth.
- Economic and financial regulations.
- Use of host nation support such as communications, water, electricity, sewerage, airports, sea ports, and so forth.
- Immunity from search, seizure, or inspection of force documents, personnel, vehicles, buildings, or areas.
- Cooperation and liaison channels between the force and local authorities.
- Employment of civil labor,
- Claim and dispute settlement.

A key subject is the exercise of civil and criminal jurisdictions. Unless the SOFA or SOMA states otherwise, peace operation forces are subject to local laws, customs, and procedures. Ordinarily, the SOFA or SOMA grants limited immunity from host nation civil and criminal jurisdiction to peace operation forces performing official duties; however, peace operation forces must respect the local laws and customs. Commanders should discuss jurisdictional provisions with their servicing staff judge advocate.

OTHER TREATIES, DIRECTIVES, AND REGULATIONS

In addition to the mandate and SOFA or SOMA, peace operations forces must be familiar with or have a working knowledge of other directives and regulations that further define and provide legal authority for the conduct of their operations.

United Nations Secretary General Directive

The SYG, upon appointing the force or mission commander, issues a formal written directive to him, outlining the TOR. He issues subsequent direction in supplementary directives.

United Nations Regulations

The force commander issues specific force regulations once a force has been established. These regulations cover such subjects as—

- General provisions such as regulations, definitions, instructions, amendments.
- International uniforms, insignia, privileges, immunities.
- Authority of the force commander such as command authority, chain of command, delegation, discipline, military police.
- General administrative, executive, and financial arrangements such as the authority of the SYG and the force commander, UN headquarters, finance and accounting, personnel, food, accommodations, amenities, transportation, supplies, equipment, communications, maintenance, medical, dental, sanitary, contracts, and public information services.
- Rights and duties of members of the force such as respect for local law, conduct, and legal protection.
- Information handling, honors and awards, jurisdiction, customs duties, foreign exchange regulations, identity cards, driving privileges, pay, overseas service allowances, dependents, leave, promotions, and service-related death, injury, or illness.
- Applicable international conventions such as the observance of international conventions applicable to military personnel.

Force Commander's Directive

The force commander's directive is also referred to as a force SOP or force standing order. Upon receipt of the UN regulations, the force commander prepares more detailed regulations and operating procedures for the force. All key members of the force must understand these procedures, since all operations are conducted in accordance with them.

Each operation is unique. SOPs are designed and issued for each force. The UN has standardized the main subject headings, which are—

- Command and control (includes force commander's briefing, force administration, headquarters, operational briefings, and contingent briefings).
- Organization (includes structure and TOR for operations, personnel, administration, logistics, communications, and civilian personnel).
- Operations (defines the mission and tasks of the force and gives details on the procedures and actions to be taken by the force to accomplish its tasks).
- Information (details collection, collation, analysis, assessment, and dissemination).
- Air operations (details aircraft, states of readiness, availability, limitations on flying, flight planning procedures, instructions on night flying, airspace control).

- Operations economics (details the aim, roles, organizations, and procedures).
- Communications (details the organization and procedures for force communications).
- Personnel and logistics (details personnel management administration and services and logistics support).
- Public information (details UN and force press policy and procedures).

Memoranda of Agreement

MOAs may be reached among the force commander, the other UN peacekeeping force contingents, and the host nation. These MOAs address administrative matters such as use of airports for rotation, national visitors, and so forth.

National Law

Members of peace operation contingents remain subject to applicable national laws, policies, and regulations of their sponsoring nations, including military criminal codes. Ordinarily, the sponsoring nation authority takes the appropriate military discipline and punitive actions—not the UN chain of command. US personnel remain subject to the UCMJ, which is administered by the US contingent commander or other appropriate US authority. US forces also remain subject to applicable domestic laws, policies, and regulations.

Annex A

Terms of Reference for US Forces Somalia, United Nations Operation in Somalia

1. **PURPOSE.** These terms of reference constitute an agreement between the Commander-in-Chief, US Central Command (USCINCCENT) and the Commander, United Nations Operations in Somalia (UNOSOM II) for the staffing, organization, and operations of US Forces, Somalia (USFORSOM).

2. **AUTHORITY.** The United Nations Security Council (UNSC) has established UNOSOM II in accordance with UNSC Resolution 814 (1993). The National Command Authorities have approved the participation of US Armed Forces as part of, and in support of UNOSOM II.

3. **MISSION.** USFORSOM will perform duties as assigned by USCINCCENT and Commander, UNOSOM II pursuant to UNSC Resolution 814 (1993).

4. **TIMING.** UNOSOM II was established on 26 March 1993 by UNSC Resolution 814 (1993). Administratively, UNOSOM II Force Command Headquarters will be operational in early May 1993. Commander, UNOSOM II Force Command will assume full responsibility for enforcement of UNSC Resolution 814 (1993) on or about 4 May or at a date mutually acceptable to him and the Commander, Unified Task Force (UNITAF), Somalia.

5. COMMAND RELATIONSHIPS.

a. USCINCCENT retains command of USFORSOM and delegates operational, tactical, and/or administrative control of USFORSOM as required to support the Commander, UNOSOM II Force Command.

b. USCINCCENT exercises command of USFORSOM through the Commander, USFORSOM, who is dual-hatted as Deputy Commander, UNOSOM II.

c. USCINCCENT retains operational control of the quick reaction force (QRF) and intelligence support element (ISE), as described in paragraphs 6b and 6c. below.

d. Commander, USFORSOM has administrative control of USFORSOM.

e. Specific command relationships not outlined in the TOR will be coordinated between Commander, UNOSOM II; Deputy Commander, UNOSOM II; and USCINCCENT. USCINCCENT retains final approval authority for all command relations involving US forces.

6. **ORGANIZATION.** The USFORSOM consists of the support force, including US personnel assigned to the UNOSOM II staff, the QRF—when directed, the ISE—when directed, and other augmentation forces, as required and when approved by USCINCCENT, to support the Commander, UNOSOM II.

a. The support force will consist of those US military combat service, combat service support personnel, and headquarters staff assigned directly to UNOSOM II.

(1) Personnel assigned to the support force will be under the operational control of the Commander, UNOSOM II, through the Commander, USFORSOM, and also serve as Deputy Commander, UNOSOM II.

(2) The primary element of the support force will consist of the Logistics Support Command, Somalia (LSCS), whose mission is:

(a) During transition to UNOSOM II, provide UNOSOM II the same level of combat service support being provided by US forces to UNITAF, until relieved by other UNOSOM II donors or UN contract services, or as directed by USCINCCENT. Transition or logistics support functions to the UN FOD¹ logistics support structure will be event-driven, not schedule-driven.

(b) After completion of the transition to UNOSOM II, be prepared to provide command, control, and management of common-item, theater-level logistics support for UNOSOM II, to include all units of USFORSOM deployed in support of UNSC Resolution 814. Provide selected common item support/common-user service support and inland distribution of bulk POL, as required to support the Commander, UNOSOM II. Further logistics functions are outlined in paragraph 7 below.

b. A QRF provides US combat capability for rapid response in support of the Commander, UNOSOM II to counter specific threats that exceed the capability of UNOSOM II units. It will not be used to spearhead routine operations, escort convoys, or perform long-term security actions. The QRF will initially be ashore in Somalia and will transition to offshore/over-the-horizon presence where conditions warrant and when directed by the US National Command Authorities.

(1) Tactical control of the QRF is delegated from USCINCCENT to Commander, USFORSOM, in the following situations:

(a) Deployment for normal unit training exercises within Somalia.

(b) Situations within Somalia that exceed the capability of UNOSOM II forces and require emergency employment of immediate combat power for a limited period or for show-of-force operations.

(2) QRF tasking outside of the above guidelines requires explicit USCINCCENT approval. However, when a situation arises requiring immediate action and prior approval is impossible or impracticable, the Commander, USFORSOM, is authorized to make the execution decision.

(3) The QRF will comply with the rules of engagement for US forces supporting UNOSOM II as established in Operation Restore Hope II, OPORD 001.

c. The ISE will be deployed by USCENTCOM to provide intelligence support to UNOSOM II and USFORSOM. All US intelligence information will be derived from and pass through the ISE. The ISE will consist of a US-only intelligence cell, US representatives to UNOSOM II headquarters, intelligence-related systems and communications personnel, and other US intelligence support activities, as required.

(1) The ISE assets will remain under the supervision and control of the US at all times. Consistent with US releasability requirements, the ISE will directly support UNOSOM II operations.

(2) The director of intelligence, USCENTCOM, has overall responsibility for developing and implementing the concept of operations for intelligence, coordinating intelligence requirements, developing the organization of the US-only ISE, and facilitating the acquisition of intelligence support systems.

¹. Now called the Field Administration and Logistics Division (FALD).

(3) There will be no bilateral intelligence exchanges with coalition forces in Somalia.

7. LOGISTICS.

a. Organization of the UNOSOM II Support Command is based on the following assumptions:

(1) UNOSOM II will operate from five area support centers, one in each of the five brigade sectors, with a general support base in Mogadishu, initially staffed largely by the LSCS.

(2) The predominant UNOSOM II contributor within each sector will accept responsibility for the area support center and provide logistics support for the entire sector.

(3) The items below are the responsibility of UNOSOM II:

(a) Perishable and nonperishable subsistence.

(b) Petroleum (fuel).

(c) Construction materials and barrier material.

(d) Water production/purification, storage, and issue/

(e) Ammunition: standard calibers.

(f) Intratheater airlift.

(g) Ground line haul.

(4) The following items are a national responsibility:

(a) Personal demand items (Class VI).

(b) Clothing, individual equipment, tools, administrative supplies.

(c) Ammunition: nonstandard calibers.

(d) Major end items: racks, pylons, tracked vehicle, and so forth.

(e) Repair parts (tactical vehicle maintenance, aviation support/maintenance).

(f) Medical support.

1 Level-I and -II medical care are national responsibilities. Level-III care for UNOSOM force is to be provided by UNOSOM designated area support facility. The US will provide LEVEL-I, -II, and -III care specifically for the US forces.

2 Class VIII (medical supplies) remains a national responsibility.

3 Casualty evacuation is a national responsibility unless specifically designated by UNOSOM II to be provided by an area support unit.

(g) Postal support and legal support.

b. Consistent with the above assumptions, initially the LSCs will provide most of the personnel and resources to stand up the UNOSOM II Support Command. The LSCS will furnish support at approximately the same level presently being provided by the UNITAF support command.

c. Once the UNOSOM II support command is operational, the LSCs will do the following:

(1) Provide command and control of logistics support to UNOSOM II.

(a) Furnish theater-level logistics management expertise.

(b) Assist Commander, UNOSOM II, in establishing procedures for the receipt, storage, and issue of materiel at the theater level.

(c) Coordinate with the UN FOD² for contracting and acquisition support to UNOSOM II. All contracting functions will be assumed by the UN FOD.¹

(d) Provide highway regulation services.

(3) Conduct materiel management control and be responsible for the management functions attendant to US common item support for combat rations, water, and bulk petroleum to UNOSOM II.

(4) Provide common item support (CIS), defined as combat rations, water, and bulk petroleum, to UNOSOM II, to include:

(a) Receipt, storage, and issue/distribution of combat rations to the area support centers.

(b) Production, purification, storage, and issue or distribution of water to the area support centers.

(c) Receipt, storage, and issue or distribution of bulk petroleum (limited to JP5 and MOGAS) to the area support centers.

d. Once the UNOSOM II support command is established and functioning, the LSCs will begin drawing down by shifting selected functions to other donors and UN contractors. This transition will be event-driven, not schedule-driven.

8. FUNDING. US support of UNOSOM II will be handled in accordance with applicable US law regarding agreements between the UN and the US government.

9. OTHER SERVICES. Administrative and technical support and services specifically not outlined in this TOR must be coordinated and negotiated among UN, US, and participating countries.

10. COORDINATION AND LIAISON. Coordination and liaison among the US and UN and other countries will be conducted as appropriate.

11. RESPONSIBILITIES OF US MILITARY PERSONNEL.

a. US Armed Forces personnel assigned to UNOSOM II will perform their duties in accordance with the rules and regulations established for the UNOSOM II force command and as directed by USCINCCENT. The QRF, ISE, and other units operating under US control will maintain current US command relationships.

b. No classified US military information of any nature that is not releasable based on appropriate directives, will be released to foreign nationals or the UN unless specifically cleared by an appropriate US official.

² Now called the Field Administration Logistics Division (FALD).

12. PRESS GUIDANCE. There will be no press release for this TOR. Specific requests for press activities with UNOSOM II will be forwarded to the UN for appropriate actions. The Department of State will remain the lead US agency for public affairs activities regarding all aspects of US participation in UNOSOM. The USCENTCOM Public Affairs Office may conduct routine public affairs activities consistent with the UN and participating government agreements.

13. MODIFICATION AND TERMINATION. Modification of the TOR will be issued by USCINCCENT in consultation with the joint staff, Office of the Secretary of Defense, Department of State, and United Nations. The TOR will be reviewed one year from the date of issuance. The TOR may be terminated by mutual agreement of the parties or by direction of USCINCCENT.

Annex B**Example of United Nations Mandate Resolution**

The UNSC, noting that the present situation with regard to (country or countries) is likely to threaten international peace and security and may further deteriorate unless additional measures are promptly taken to maintain peace and to seek out a durable solution.

Considering the positions taken by the parties in relation to the "peaceful intentions" signed at New York on (date). Having in mind the relevant provisions of the charter of the UN and its Article 2, paragraph 4, which reads: "All members shall refrain in their international relations from the threat or use of force against the territorial integrity manner inconsistent with the purposes of the United Nations."

a. Calls upon all member states, in conformity with their obligations under the charter of the UN, to refrain from any action or threat of action likely to worsen the situation in () and (), or to endanger international peace.

b. Asks the governments of (), which have the responsibility for the maintenance and restoration of law and order, to take all additional measures necessary to stop violence and bloodshed in their countries.

c. Recommends the creation, with the consent of the governments of (), of a UN peacekeeping force in those countries. The composition and size of the force shall be established by the SYG, in consultation with the governments of (). The commander of the force shall be appointed by the SYG and report to him. The SYG, who shall keep the governments providing the force fully informed, shall report periodically to the UNSC on its operation.

d. Recommends that the function of the force should be, in the interest of preserving international peace and security, to use its best efforts to prevent a recurrence of fighting and, as necessary, to contribute to the maintenance and restoration of law and order and a return to normal conditions.

e. Recommends that the stationing of the force shall be for a period of three months, all costs pertaining to it being met in a manner to be agreed upon by the governments providing the contingents and by the governments of (). The SYG may also accept voluntary contributions for that purpose.

f. Recommends further that the SYG designate, in agreement with the governments of (), a mediator, who shall use his best endeavors with the representatives of the communities and also with the aforesaid governments for the purpose of promoting a peaceful solution and an agreed-upon settlement to the problem confronting (), in accordance with the charter of the UN, having in mind the well-being of the peoples of () as a whole and the preservation of international peace and security. The mediator shall report periodically to the SYG on his efforts.

g. Requests the SYG to provide, from funds of the UN, as appropriate for the remuneration and expenses of the mediator and his staff.

Annex C**Extract of the UN Charter****Chapter VI****Pacific Settlement of Disputes****Article 33**

1. The parties to any dispute, the continuance of which is likely to endanger the maintenance of international peace and security, shall, first of all, seek a solution by negotiation, enquiry, mediation, conciliation, arbitration, judicial settlement, resort to regional agencies or arrangements, or other peaceful means of their own choice.

2. The Security Council shall, when it deems necessary, call upon the parties to settle their dispute by such means.

Chapter VII**Action With Respect to Threats to the Peace,
Breaches of the Peace, and Acts of Aggression****Article 39**

The Security Council shall determine the existence of any threat to the peace, breach of the peace, or act of aggression and shall make recommendation, or decide what measures shall be taken, in accordance with Articles 41 and 42, to maintain or restore international peace and security.

Article 41

The Security Council may decide what measures not involving the use of armed force are to be employed to give effect to its decisions, and it may call upon the Members of the United Nations to apply such measures. These may include complete or partial interruption of economic relations and of rail, sea, air, postal, telegraphic, radio, and other means of communication, and the severance of diplomatic relations.

Article 42

Should the Security Council consider that measures provided for in Article 41 would be inadequate or have proved to be inadequate, it may take such action by air, sea, or land forces as may be necessary to maintain or restore international peace and security. Such action may include demonstrations, blockade, and other operations by air, sea, or land forces of Members of the United Nations.

APPENDIX B

United States Government, United Nations, and Other International Organizations

*Now is the time to explore joint
agency ventures . . .*

Admiral Paul David Miller
CINC USACOM

US Army forces conduct peace operations directed by the NCA in close cooperation with or under the supervision of other agencies, the UN, and NGOs. This appendix provides commanders and their staffs with information about possible players in peace operations with whom they may be unfamiliar. It includes descriptions of these entities and their functions and roles but is not an exhaustive treatment of all possibilities.

UNITED STATES GOVERNMENT AGENCIES

Units may work with any number of United States Government agencies, to include the NCA, the National Security Council (NSC), other DOD agencies, DOS, AID, the Aid Office for Foreign Disaster Assistance (AOFDA), the Federal Emergency Management Agency (FEMA), the Department of Transportation, the Coast Guard, the Department of Agriculture (USDA), the Department of Justice, the Office of International Affairs, the Public Health Service (PHS), and the Immigration and Naturalization Service (INS).

NATIONAL COMMAND AUTHORITIES

The NCA consists of the President and the Secretary of Defense (SECDEF) together or their duly deputized alternates or successors. Both movement of troops and execution of military action must be directed by the NCA, no one else in the chain of command has such authority. The NCA directs armed forces involvement in opera-

tions. Orders given to the US forces commander must include the appropriate NCA mandate (instructions) for the operation.

NATIONAL SECURITY COUNCIL

The NSC develops policy guidance for employment of military assets and conduct of operations. The NSC provides a representative to any established interagency oversight committee when requested by the SECDEF.

DEPARTMENT OF DEFENSE

The Office of the SECDEF has several assistants who may be involved in the conduct of peace operations.

Assistant Secretary of Defense for Strategy and Requirements

The Assistant Secretary for Strategy and Requirements (ASD[S&R]) is the principal staff assistant and advisor to the Under Secretary of Defense for Policy (USD[P]) and the SECDEF on DOD policy and planning for US participation in

international PK and PE operations. In these capacities, the ASD(S&R) shall develop, coordinate, and oversee the implementation of policy and plans for matters related to the participation of US armed forces and other DOD resources in UN and other international peacekeeping or peace enforcement activities. This includes the development of policy related to creating, identifying, training, exercising, and committing military forces for such purposes. A Deputy Assistant Secretary of Defense for Peacekeeping and Peace Enforcement (DASD[PK/PE]) serves under the ASD(S&R).

Assistant Secretary of Defense for Special Operations and Low-Intensity Conflict

The Assistant Secretary of Defense for Special Operations and Low-Intensity Conflict (ASD[SO/LIC]) is the principal staff assistant and civilian advisor to the Secretary of Defense and the USD(P) for policy-

and planning-related special operations and low-intensity conflict activities within DOD. Many peace operations are low-intensity conflicts or have the characteristics of low-intensity conflicts. SOF, especially CA, PSYOP, and SF units, have unique capabilities and responsibilities for peace operations. ASD(SO/LIC), among other responsibilities—

- Provides policy guidance and oversees planning, programming, resourcing, and execution of SO and LIC activities.
- Provides policy concerning PSYOP forces, plans, and programs.
- Oversees integrated development and refinement of doctrine, strategies, and processes for SO and LIC, to include supporting studies and analyses.
- Reviews and evaluates policies, processes, and programs of DOD components to plan,

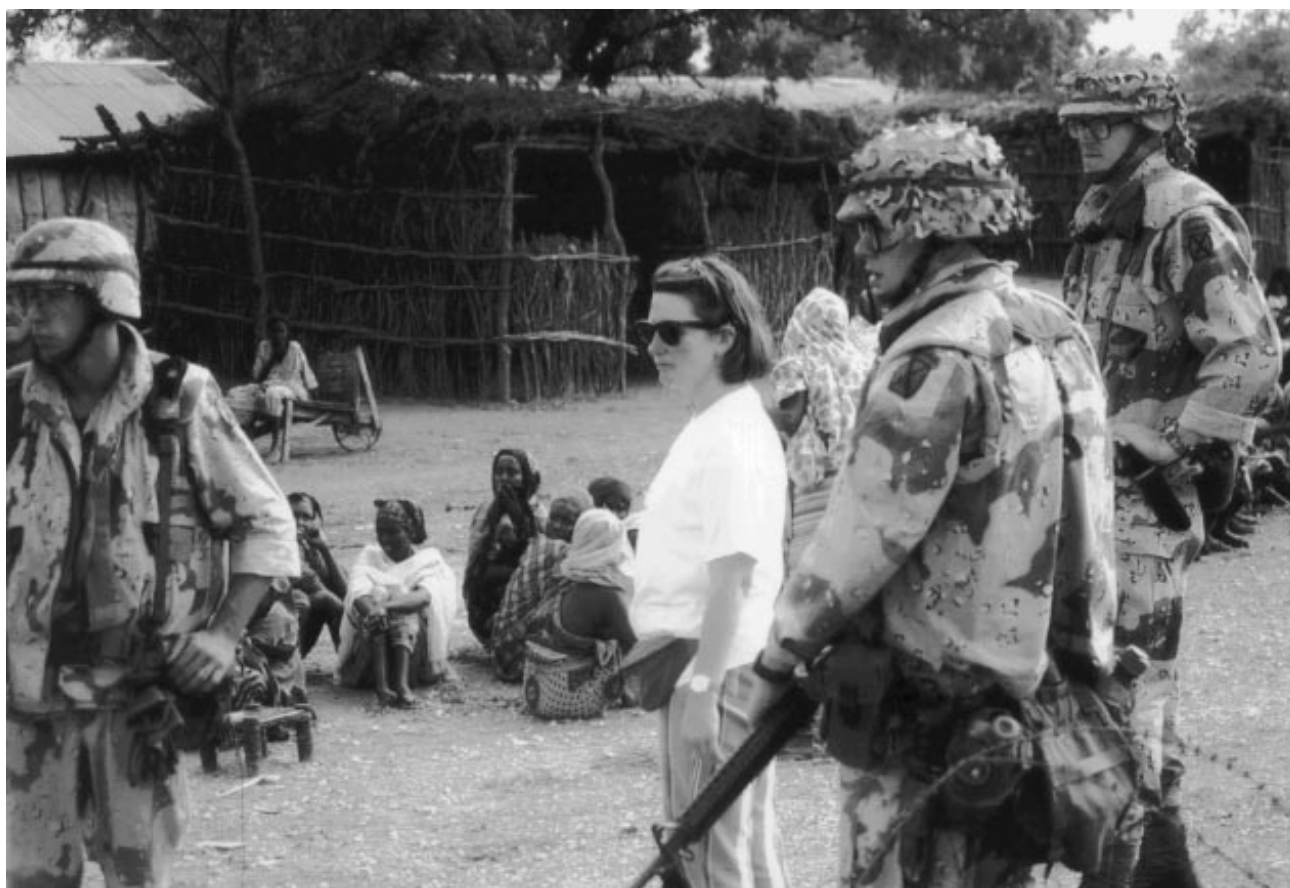

In peace operations, units may work with any number of US Government or nongovernment agencies.

resource, prepare forces, and execute SO and LIC operations and initiate and coordinate action to enhance readiness.

- Supervises overall preparation and justification of program recommendations and budget proposals for SO activities in the Five Year Defense Plan (FYDP).
- Advises the Under Secretary of Defense (Acquisition) (USD[A]) on acquisition priorities and requirements for SO and LIC-related materiel and equipment, to include participation in appropriate boards and committees.
- Serves as principal staff assistant and advisor to the USD(P) and SECDEF for—
 - DOD support to the President's counter-drug strategy.
 - DOD humanitarian assistance programs and other humanitarian issues, including refugees and laws of war.
 - US international information programs.

Defense Security Assistance Agency

The Defense Security Assistance Agency (DSAA) directs, administers, and supervises the execution of security assistance programs. This involves providing guidance to military services, unified commands, and in-country security assistance officers in their efforts to assist foreign governments obtain US equipment, training, and other defense-related services authorized by the *Foreign Assistance Act*, as amended, and the *Arms Export Control Act*.

DEPARTMENT OF STATE

The Department of State is responsible for the formulation and implementation of US foreign policy.

Authority and Responsibilities

In a given country, DOS authority is delegated to one of several principal staff assistants. The Secretary of State (SECSTATE) provides a senior DOS representative to any interagency or interdepartmental HA oversight committee, as requested by the SECDEF. The DOS may provide primary policy guidance in the following areas:

- Matters having an impact on US relations

with other countries.

- The extent to which commanders interfere in the government of a particular country.
- The level at which the economy of a country is maintained.
- Matters involving informational programs, supporting psychological aspects, and attitudes of the indigenous population.
- The level of subsistence for civilians in a country in which US forces are stationed or employed and by whom such subsistence in part or in whole must be provided.
- Plans or procedures for the return of civil government functions to civilian control.
- Efficiency and costs of programs undertaken to gain the understanding, acceptance, confidence, and support of civil populations.
- Embassy or consulate emergency action plans (EAPS) for the city or area under their cognizance. These plans and photographs could be beneficial to the forces involved in missions. The information they provide includes evacuation sites, landing zones (LZs), ports, and beaches; the number of evacuees (if required); assembly areas; command posts.
- Acts of terrorism. If the host nation is unable to adequately protect itself from acts of terrorism, the DOS can provide support through its antiterrorism assistance (ATA) program to teach host nation officials governance and law enforcement. The latter should include how to maintain the internal security of the nation. In particular, Federal Aviation Administration instruction on airport procedures and security could be included.

Important State Department Embassy Positions

Commanders involved in peace operations should be familiar with the duties of the following State Department officials and organizations normally found at US embassies.

Ambassador/Chief of Mission. The ambassador, or chief of mission, is the senior US official, military or civilian, at the embassy. The ambassador usually has overall direction, coordination, and supervision of US Government activities and

personnel in a host country. This authority does not extend to personnel in other missions or those assigned to either an international agency or to a combatant commander. A crisis may arise where the US has no diplomatic mission. In such a situation, the President may send a representative with instructions that vary from the standard authorities and responsibilities of a chief of mission.

During cross-border emergencies, the US ambassador to the host nation normally exercises command and control in the interagency environment. However, this control may be complicated when cross-border emergencies such as civilians crossing international borders or attacks against refugee camps take place. Therefore, interagency working groups should establish procedures on cross-border situations.

Deputy Chief of Mission. The deputy chief of mission (DCM) is the senior diplomatic official in an embassy below the rank of ambassador. He has the diplomatic title of minister, minister-counselor, or counselor (depending upon the size of the mission) and is nearly always a career Foreign Service officer (FSO). The DCM usually chairs the country team meetings and coordinates the embassy staff.

Chief of Military Mission. The chief of military mission is the senior military person at the embassy. He maintains liaison with the host nation's military forces. He is authorized by law to perform certain military functions with host country military barred to others. He is cognizant of the advance party forward command element (FCE).

Chief of Station. The chief of station is the person responsible for gathering HUMINT and signal intelligence (SIGINT) and informing the ambassador.

Defense Attache Officer. The defense attache officer (DAO) is the military person attached to the embassy in a diplomatic status representing DOD. This officer can facilitate access to the daily embassy situation report (SITREP) and other written intelligence. All military personnel, even those not assigned to the embassy or under direct control of the ambassador, must coordinate their activities through the DAO.

Security Assistance Officer. The security assis-

tance officer is the person assigned to carry out security assistance management functions, primarily, logistics management, fiscal management, and contract administration of country security assistance programs.

Administration Officer. The administration officer is responsible for various activities at the embassy compound, which may include providing security at small posts; running the commissary, motor pool, and maintenance activities; and handling monetary aspects of the embassy business, including foreign service national (FSN) payroll, cash collection, and budget. The AO is the third in command in the embassy hierarchy. In a small post with no security officer assigned, the AO assumes the functions of the security officer.

Political Officer. A political officer is an FSO who reports on political developments, negotiates with governments, and represents views and policies of the US Government to his contacts. The political officer maintains regular contact with host government officials, political and labor leaders, and other influential citizens of a country, as well as third country diplomats. The political officer is a major contributor to the overall intelligence picture.

Economic Officer. The economic officer analyzes, reports on, and advises superiors and DOS personnel on economic matters in the host country. Economic officers also negotiate with the host government on trade and financial issues. They may also work in close contact with relief organizations.

Consular Officer. The main function of the consular officer is to screen, process, and grant US passports and visas. Other duties include attending to the welfare of US citizens and performing administrative tasks such as maintaining a count of US nationals within the host country. The consular officer provides appropriate personnel to screen documents of all potential evacuees during noncombatant evacuation operations (NEO) and provides any necessary instructions that personnel may need to effectively staff processing stations.

Medical Officer. The medical officer is qualified for general practice and responds to and sets up triage, trauma, and mass casualty operations.

The medical officer also advises on indigenous disease vectors and proper prophylaxis necessary for forces introduced into the country.

Public Affairs Officer. The USIA (US Information Service [USIS] overseas) representative of the country team normally serves as the public affairs officer (PAO) to provide public affairs advice to the ambassador and coordinate information efforts with other agencies.

Regional Security Officer. The regional security officer (RSO) is a security officer responsible for the security functions of US embassies and consulates in a given country or group of adjacent countries.

Post Security Officer. The post security officer (PSO) has general security duties at a specific embassy (or consulate). The PSO is a special staff officer under the control of the AO.

Special Security Force. The special security force consists of DOS employees who respond to crises in foreign countries. They work for the RSO and provide additional bodyguard security for the ambassador, the DCM, and others.

General Services Officer. The general services officer performs many of the same functions as a G4 or S4. He is normally responsible for buildings, grounds, construction, vehicles, and maintenance.

Marine Security Guard Detachment. The non-commissioned officer in charge (NCOIC) of the Marine Security Guard (MSG) Detachment is normally a member of the EAC and is responsible to the PSO for internal security, protection of classified material, and American lives. An MSG detachment normally has 5 to 35 personnel assigned. The detachment is not available for duty with incoming forces, except with the express consent of the ambassador.

Country Team. The country team consists of the ranking representatives of embassy sections and other US Government agencies operating within a country. Chaired by the ambassador or the DCM, the country team meets regularly to advise the ambassador on US matters and to review current developments in the country. Included in the country team are the—

- Ambassador.
- DCM.

- Chief of political section.
- Political and military affairs officers.
- Consular officer.
- Administrative officer.
- Economics officer.
- USIS representatives.
- DEA, AID, and Peace Corps representatives.
- CIA, DAO, and military assistance group (MAG).
- Security assistance officer.

The country team facilitates interagency action on recommendations from the field and implements effective execution of US programs and policies.

UNITED STATES AGENCY FOR INTERNATIONAL DEVELOPMENT

USAID is an agency under the policy direction of the DOS that coordinates US foreign assistance efforts. In a peace support operation, armed forces work closely with USAID staff. USAID emphasizes—

- Stimulation of market economies and investment by US companies in developing nations.
- Improvement of schools, colleges, training organizations, supportive government ministries, and other institutions to support economic growth.
- Policy reform to advance development.
- Transfer of technology to help countries produce their own resources.

Foreign economic assistance provided by USAID is normally in the form of development assistance loans and grants to improve the quality of life of the poorest people in less developed countries. It also includes the Economic Support Fund, part of the Security Assistance Program. The SECSTATE and the USAID administrator make policy decisions concerning the Economic Support Fund Program. The fund includes balance of payment support and financing of infrastructure and other capital projects. Food is administered in close cooperation with the USDA.

UNITED STATES AID OFFICE FOR FOREIGN DISASTER ASSISTANCE

AOFDA is the federal agency responsible for providing prompt nonmilitary assistance to alleviate loss of life and suffering of foreign disaster victims. AOFDA may request DOD assistance during HA operations. Coordination and determination of required forces is normally accomplished through the Assistant Secretary of Defense for International Security Affairs (ASD[ISA]) and the JCS.

UNITED STATES INFORMATION AGENCY

The USIA (US Information Service [USIS] overseas) helps to achieve US foreign policy objectives by influencing public attitudes overseas. The agency advises the President and US departments outside CONUS on the possible impact of policy, programs, and official statements on foreign opinion. USIA monitors the impact of peace support operations on local attitudes and aids peace operation forces by gaining popular support for them. To encourage public support for US policy objectives and to counter hostile attempts to distort and frustrate US programs, USIA conducts a wide range of information activities.

FEDERAL EMERGENCY MANAGEMENT AGENCY

FEMA coordinates federal, state, and local resources on issues of national security, emergency preparedness, civil defense, continuity of mobilization preparedness, and continuity of government and technological disasters within the US, its territories, and possessions. FEMA has the authority to direct DOD assistance to state and local governments to save lives and protect property, public health, and safety. Peace operation forces may facilitate FEMA-DOD planning and coordination of assessments consistent with their mission and ease suffering, consistent with established procedures and national defense priorities.

DEPARTMENT OF TRANSPORTATION

DOT has technical capabilities and expertise in public transportation that may be available upon request to assist specific HA operations.

The primary organization with which peace operation forces may work is the Coast Guard.

The Coast Guard (USCG) is responsible for federal maritime law enforcement and port security in peacetime and is a military service under the Department of the Navy in wartime. The USCG has expertise in areas of shipping, commerce, marine life industry, and conservation. USCG international training efforts provide a mechanism for sharing its expertise abroad; such expertise can be made available for peace support operations, if needed. Additionally, results of DOD and DOT projects related to peace support missions are available upon request.

DEPARTMENT OF AGRICULTURE

The Department of Agriculture (USDA) has projects and activities ongoing in foreign countries and can provide technical assistance to peace support forces, if requested. Coordinated DOD and projects and teams can be developed for specific countries or regions.

DEPARTMENT OF JUSTICE

The Department of Justice agencies with which HA forces may come into contact include DEA and Community Relations Service (CRS).

Drug Enforcement Agency

DEA coordinates DOD peace support operations. DEA programs and projects can be developed for specific countries and regions. The DEA can—

- Assist in providing legal, self-sustaining, income-earning alternatives to underdeveloped, agriculturally based nations.
- Improve international exchange of information about successful drug prevention and education programs.

Community Relations Service

CRS is under the general authority of the attorney general. CRS provides on-site resolution assistance through a field staff of mediators and conciliators. CRS not only aids in resolving difficulties as they erupt but also seeks to assist and support communities in developing mechanisms to address future problems.

Office of International Affairs

The Office of International Affairs coordinates and supports Department of Justice international efforts and supports the DOS during international treaty negotiations.

PUBLIC HEALTH SERVICE

The promotes the protection and advancement of a nation's physical and mental health. Peace support forces are most likely to work with the PHS when bringing migrants or refugees into the US or US territories. PHS ensures that no health threat is posed by such immigrations.

IMMIGRATION AND NATURALIZATION SERVICE

The INS provides information and service to the general public while enforcing immigration control. The INS—

- Facilitates the entry of persons legally admissible as visitors or as immigrants of the US.
- Grants benefits under the *Immigration and Nationality Act*, including assistance to those seeking permanent resident status or naturalization.
- Prevents unlawful entry to the US.
- Apprehends and removes aliens who enter or remain illegally in the US or whose stay is not in the best interests of this nation.

UNITED NATIONS ORGANIZATIONS

UN organizations primarily concerned with peace operations include the High Commissioner for Refugees, the Disaster Management Team (UN-DMT), and the Department of Humanitarian Affairs (UNDHA).

UNITED NATIONS HIGH COMMISSIONER FOR REFUGEES

The UNHCR has a major role in coordinating aid to refugees, returnees, and displaced persons. Except in special circumstances, it material

assistance activities are conducted through national or local authorities of the country concerned, other organizations of the UN system, NGOs, or private technical agencies.

Coordination with the UNHCR is critical for any humanitarian relief effort. Failure to coordinate with UNHCR before and during the operation, or failure to meet UNHCR standards, may preclude the UNHCR from accepting transfer of equipment, supplies, and facilities as the military disengages. To preclude this, a working relationship should be established with UNHCR immediately upon notification of a mission with UNHCR. A copy of the UNHCR text that outlines specifications for refugee camp construction should be available.

UNITED NATIONS DISASTER MANAGEMENT TEAM

The UN-DMT is the primary agency responsible for coordinating assistance to persons compelled to leave their homes as a result of disasters, natural and otherwise.

United Nations Department Of Humanitarian Affairs

UNDHA is the focal point for disaster management in the UN system. It mobilizes and coordinates international disaster relief, promotes disaster mitigation (through the provision of advisory services and technical assistance), and promotes awareness, information exchange, and the transfer of knowledge on disaster-related matters.

UNDHA is responsible for maintaining contact with disaster management entities and emergency services worldwide and is able to mobilize specialized resources. The appointed UNDHA resident coordinator has a crucial role in providing leadership to the UN team at country level. He also coordinates locally represented PVOs and NGOs as required. The resident coordinator convenes the UN-DMT at country level, seeking unity of effort among all the various PVOs, NGOs, and agencies. The following UN programs can be expected in the AO. They help form the UN-DMT when the UN system has been mobilized to assist in the emergency.

United Nations Development Program

The UN Development Program (UNDP) promotes the incorporation of disaster mitigation in development planning and funds technical assistance for all aspects of disaster management. Work is long range. The UNDP senior member may be appointed as a regional coordinator or may also serve as the UNDHA in-country coordinator. UNDP also provides administrative assistance support to the resident coordinator and to the UN-DMT.

World Food Program

The World Food Program (WFP) is an operational, relief-oriented organization. It provides targeted food aid and supports rehabilitation, reconstruction, and risk-reducing development programs. Targeted food aid is special subsistence aligned to a special segment of the population. This organization mobilizes and coordinates the delivery of complementary emergency and *program* food aid from bilateral and other sources.

United Nations Children's Fund

The United Nations Children's Fund (UNICEF) is a relief-oriented organization. It attends to the well-being of children and women, especially child health and nutrition. The activities of this organization may include social programs, child feed (in collaboration with WFP), water supplies, sanitation and direct health intervention (in coordination with the World Health Organization [WHO]). UNICEF provides related management and logistical support.

World Health Organization

WHO is an organization involved more in long range programs. It provides advice and assistance in all aspects of preventive and curative health care. This assistance includes the preparedness of health services for rapid response to disasters.

Food and Agriculture Organization of the United Nations

The Food and Agriculture Organization (FAO) is an organization also involved in long-

range programs. It provides technical advice in reducing vulnerability and helps in the rehabilitation of agriculture, livestock, and fisheries. The organization emphasizes local food production. It also monitors food production, exports and imports, and forecasts any requirements for exceptional food assistance.

OTHER INTERNATIONAL ORGANIZATIONS

Other international organizations include the American Council for Voluntary International Action and PVOs and NGOs.

AMERICAN COUNCIL FOR VOLUNTARY INTERNATIONAL ACTION (INTERACTION)

The American Council for Voluntary International Action is a broadly based coalition of 120 American PVOs that work in international development, refugee assistance, public policy, and education of Americans in third world nations. Since 1984, it has played a significant role in disaster preparedness and response to disasters. It exists to complement and enhance the effectiveness of its member organizations and the PVO community as a whole.

A grant from AOFDA has helped this organization establish a professional forum for cooperation, joint planning, and exchange of information when disaster occurs. However, it is not likely that interaction will occur within the country in need of assistance. The work of the council is executed in the US and is geared to maintain an effective liaison with AOFDA. It acts as a coordinator at the staff level in meeting requirements identified by its members operating within the country in need.

PRIVATE VOLUNTARY AND NONGOVERNMENT ORGANIZATIONS

The list of PVOs and NGOs that may be found in an AO could be very large. Approximately 350 agencies capable of conducting some form of humanitarian relief operation are registered with the USAID. Also, many foreign-based

organizations are not required to register in the US. USAID publishes a yearly report, titled *Voluntary Foreign Aid Programs*, that describes the aims and objectives of the registered organization. It should be part of the combatant commander's library. The following humanitarian PVOs and humanitarian relief organizations (HROs) may be found in an AO.

**American Friends of Action
Internationale Contre La Faim**

American Friends of Action Internationale Contre La Faim (AIFC) promotes development efforts and provides emergency assistance in African, Asia, and the Caribbean. It focuses on primary health care, potable water, environmental sanitation, and agriculture-based income generation. The most basic commitment is to enhance local capacities at both the community and central levels.

Catholic Relief Services

Catholic Relief Services operates relief, welfare, and self-help programs in 74 countries to assist refugees, war victims, and other needy people. CRS emphasizes the distribution of food and clothing and the provision of primary health care. Their capability to provide technical assistance and social services has steadily increased in recent years.

**Cooperative for American Relief
Everywhere, Incorporated**

Cooperative for American Relief Everywhere, Inc. (CARE) conducts relief and development programs in over 40 countries in Asia, Africa, Latin American, and the Caribbean. Programs are carried out under three-way partnership contracts among CARE, private or national government agencies, and local communities in the areas of health, nutrition, acquired immune deficiency syndrome (AIDS), population management, natural resources management, agriculture, small economic activities, and emergency assistance. CARE provides technical assistance, training, food, other material resources, and management in combinations appropriate to local needs and priorities. Their particular strength is in food distribution, emergency transport and general logistics.

**Doctors Without Borders/
Medicines Sans Frontiers**

Medicines Sans Frontiers (MSF) provides medical assistance to victims of disasters, accidents, and war. The US organization is closely associated with its counterparts in Belgium, Holland, Spain, and France. Medical relief teams depart on over 700 yearly missions to areas of conflict, refugee camps, national disaster sites, and areas lacking adequate health care facilities. Their particular areas of expertise are emergency medicine, vaccinations, and basic hygiene services.

The International Medical Corps

The International Medical Corps (IMC) provides health care and establishes health training programs in developing countries and distressed areas worldwide. They specialize in areas where few other relief organizations operate. IMCs goal is to promote self-sufficiency through health education and training. Its particular areas of expertise are immunizations and primary health care.

International Rescue Committee

The International Rescue Committee (IRC) assists refugees and internally displaced victims of war and civil strife. Services range from emergency relief and assistance programs to refugee resettlement in the US. IRC monitors human service delivery and refugee processing for US resettlement. IRC can provide emergency medical support, public health, and small-scale water and sanitation capabilities.

Irish Concern

Irish Concern (IC) is one of the foreign NGOs that receives funding from USAID and AOFDA. Its primary area of expertise is supplementary and therapeutic feeding and sanitation.

Lutheran World Relief, Incorporated

Lutheran World Relief, Inc. (LWR) provides financial, material, and personnel support, usually through counterpart church-related agencies, in the areas of disaster relief, refugee assistance, and social and economic development. LWR is also competent in the provision of health care.

Save the Children Federation

Save the Children Federation-UK (SCF-UK) programs are guided by a set of principles that include identifying project goals and implementing projects, transferring necessary skills, encouraging self-help, and using available resources. This organization is more relief-oriented than its US counterpart. It concentrates on supplementary feeding, seeds and tools, and general infrastructure.

World Vision Relief and Development, Incorporated

World Vision Relief and Development (WVRD), Inc., or Vision, provides cash, gifts in-kind, services in-kind, and technical resources for large-scale relief and rehabilitation and development projects in over 90 countries throughout the world. Development programs include child survival, vitamin A, prosthetics and handicap rehabilitation, child development, and AIDS prevention and education.

INTERNATIONAL RED CROSS MOVEMENT

The International Red Cross and Red Crescent Movement is formed by the International Committee of the Red Cross, the International Federation of Red Cross and Red Crescent Societies, and the National Red Cross and Red Crescent Societies. The statutes of the international Red Cross and Red Crescent Movement give the movement other tasks in situations not covered by the Geneva Conventions.

International Committee of the Red Cross

The International Committee of the Red Cross (ICRC) works for the faithful application of the provisions of international humanitarian law that applies in armed conflicts and undertakes the tasks incumbent upon it under this law. ICRC is an independent organization based in Geneva. It derives its mandate from the Geneva Conventions of 1949 and the additional protocols of 1977. Although at times it may get involved in strictly humanitarian operations, its mandate is to function only during armed conflict.

ICRC neutrality is a vital aspect of its involvement in any relief operations. The ICRC protects its neutrality in terms of reality and perception because it operates on all sides of a dispute to protect victims of armed conflict, to include internal disturbances and tension. ICRC neutrality is a key consideration for military planners and operators.

International Federation of Red Cross and Red Crescent Societies

The member organizations are the Red Cross and Red Crescent Societies that normally operate within the borders of their own country. Their mandate is to provide humanitarian relief during disasters. Red Cross organizations may provide assistance to other federation members through their international alliance provisions. The basic considerations for planners is to remember that these organizations also go the great length to preserve their neutrality.

APPENDIX C

Training

We will not have room for specialists. We must develop a team that plays both ways, a team that is scrappy and willing to perform many missions, a team that is versatile and agile.

General Frederick M. Franks, Jr.

Training and preparation for peace operations should not detract from a unit's primary mission of training soldiers to fight and win in combat. *The first and foremost requirement for success in peace operations is the successful application of warfighting skills.* Peace operations are not a new mission and should not be treated as a separate task to be added to a unit's mission-essential task list (METL). However, units selected for these duties require time to train and prepare for a significant number of tasks that may be different from their wartime METL. The amount of training required and when the training is given will depend on the particular peace operation mission. However, the philosophy used to determine the *how much* and *when* training questions for operations other than war can be summed up as *just enough* and *just in time*.

PREDEPLOYMENT TRAINING

Most facets of normal military operations apply to peace operations, particularly personal discipline. However, peace operations require an adjustment of attitude and approach. On the other hand, many facets of normal military training apply to peace operations.

To accomplish peace operations, individuals and units need training in various skills and techniques before deployment to change their focus from wartime to the unique demands placed on soldiers in peace operations. For example, in PK, soldiers may only use force in self-defense. The urgent need to deploy forces often precludes a complete and lengthy training program. However, with prior planning, TSPs, MTTs, and CTCs can be used to assist commanders in preparing soldiers for these missions.

Many of the skills that enable a unit to accomplish its primary mission, such as intelligence and observation and reporting, apply in

peace operations. Training to enhance these skills should be part of the predeployment training program.

INTELLIGENCE

An important aspect of training for a peace operations mission is to understand that the force is a potential target of foreign intelligence and terrorist activities.

OBSERVATION AND REPORTING

Observing and reporting are the primary functions of a force involved specifically with PK. Individuals must be familiar with the standard reporting formats that include the following reports: situation, shooting, overflight, and aircraft sighting. Personnel should learn to recognize the aircraft, vessels, vehicles, dress, and equipment of all sides.

Learning to function properly in an observation post is essential. Small units must learn the

typical layout of an observation post and check-point, as well as the general daily duty routine at an observation post. A unit may live and work at an observation post for days at a time, isolated from its parent organization.

UNIT TRAINING

Time required to train units selected for peace operations varies according to the complexity of the mission and unit. For planning purposes, units require from 4 to 6 weeks of specialized training. To be effective, the unit has to tailor its entire training methodology toward the tasks required. The unit training program will depend on whether the primary mission is PK or PE.

PEACEKEEPING

Key subjects that should be included in unit training for PK missions are—

- The nature of PK.
- The establishment of lodgments.
- The performance of relief in place.
- Regional orientation.
- Establishment of a buffer zone.
- Supervision of a truce or cease-fire.
- The monitoring of boundaries.
- Contributions to maintenance of law and order.
- Negotiating skills.
- Mine and booby trap training and awareness.
- Assistance in rebuilding of infrastructure.
- Checkpoint operations.
- Investigation and reporting.
- Information collection.
- Patrolling.
- Media interrelationships.
- Staff training.
- Demilitarization of forces and geographical areas in a permissive environment.
- ROE.

PEACE ENFORCEMENT

In addition to those subjects required for PK, subjects that should be included in unit training for PE operations are—

- Fighting a meeting engagement.
- Conducting movement-to-contact and search and attack.
- Performing air assault.
- Enforcing UN sanctions.
- Protecting the human rights of people.
- Protecting humanitarian relief efforts.
- Separating warring factions.
- Disarming belligerent parties of heavy offensive weapons.
- Restoring territorial integrity.
- Restoring law and order.
- Demilitarizing forces and geographical areas in a nonpermissive environment.
- Opening secure routes.
- ROE.
- Civil-military operations.
- Control of multinational units.
- Intelligence fusion and dissemination
- NGO operations.
- Multinational logistics.
- PSYOP.
- Intercultural communication.
- Raids, attacks, and defense

The entire chain of command must develop a different mind set than that required for fighting wars. Nevertheless, the force must always be prepared to protect itself or conduct combat operations. Examples of in-country premission, PK, and TOE mission training material can be found in the XVIII Airborne Corps SOP for Support of MFO in the Sinai. In addition, commanders may wish to consider PA media training for the chain of command and soldiers.

LEADER DEVELOPMENT

Leader development may be the single most important factor in achieving success. Peace

operations require skill, imagination, flexibility, adaptability, and patience. Emphasis during training must be placed on developing these leadership skills, as well as knowledge of the cultures involved in the operation.

INDIVIDUAL TRAINING

Individual training for peace operations duties should emphasize the personal characteristics of patience, flexibility, self-discipline, professionalism, impartiality, tact, and inquisitiveness. These characteristics have connotations that may be unique in a peace operations environment.

PATIENCE

Patience is an important characteristic for individuals in all peace operations. Negotiations often produce results slowly and time may seem to stand still. Training should help soldiers adjust their expectations to the circumstances surrounding their mission.

PROFESSIONALISM

The credibility of a force involved in peace operations can be significantly damaged by unprofessional activities, both on and off duty, which in turn can affect its relationship with the parties in the conflict. All members of the force must be knowledgeable and trained in all aspects of the mission.

IMPARTIALITY

A force must guard against unequal treatment and avoid controversial, off-the-record remarks that may reach unintended audiences. These comments may lead to a demand for the offender's removal and, if reflecting a prejudice believed to be widely held in a national contingent, to pressure for the withdrawal of the entire national contingent.

INQUISITIVENESS

The normal routine of daily life should become so familiar that soldiers notice even small events that could be of importance if matched with information from other observers. All personnel involved in peace operations must receive training on the customs of the local population and coalition partners.

Training should emphasize security and patrolling and the ROE that will apply to the operations. Individuals who staff checkpoints on major roads must be taught to slow and observe traffic without stopping it. This procedure will allow them to observe and report traffic passing from one zone to another.

Vehicles and personnel entering and exiting installations should be stopped and searched for contraband and explosives. Personnel must learn not only how to search but also how to search courteously without undue force.

SUSTAINMENT TRAINING

Once deployed, the force should be able to continue its mission training. Time permitting, the force may also train in items that require recurring emphasis such as common task training. Training may be restricted by an agreement among the parties in the conflict. However, once the force is formed, it may be possible to establish a schedule that enables the force to train on METL requirements on a regular basis.

Unit commanders should plan to conduct METL training when not actively involved in the peace operation. For a multinational and perhaps multilingual force to operate effectively, it must periodically train together. Although the commander and subordinate officers, regardless of nationality, must reconnoiter likely crisis points with discretion, they should perform training where it is unlikely to alarm the local population and the parties in the conflict.

POSTOPERATIONS TRAINING

Peace operations require a significant change in orientation for military personnel. Before the peace operations mission, training is provided to transition the wartime-ready individual to one constrained in most, if not all, actions. At the conclusion of the peace operation, certain actions are necessary to reorient the soldier to the unit's wartime METL. Commanders must allocate sufficient resources and time for training in order to achieve collective and individual standards required to meet the unit's primary warfighting mission.

Unit commanders must allow sufficient time and allocate sufficient resources after a peace operation mission for refresher training. This refresher training is for redeveloping skills and abilities that may have been unavoidably

affected by the nature of the peace operation. This refresher will require a training program to hone skills necessary to return the unit to a war-time-ready status.

APPENDIX D

SAMPLE RULES OF ENGAGEMENT

Meanwhile, I shall have to amplify the ROE so that all commanding officers can know what I am thinking, rather than apply their own interpretation, which might range from "ask them for lunch to 'Nuke' em for breakfast."

Admiral "Sandy" Woodward
Commander of the Task Force
(Falkland Islands, 1982)

This appendix provides actual unclassified ROE and instructions for use of force and weapons policy as samples. The purpose of this appendix is to familiarize commanders and their staffs with the types of rules and instructions and various formats and means of dissemination used by US Army forces in recent operations.

The selected operations include Operation Restore Hope—the UN-sanctioned humanitarian relief and enforcement operation conducted in Somalia in 1992 and 1993—and Operation Provide Comfort—a UN-sanctioned humanitarian protection operation conducted in Northern Iraq in 1991.

RULES OF ENGAGEMENT FOR OPERATION RESTORE HOPE

1. (U) Situation. Basic OPLAN/OPORD.
2. (U) Mission. Basic OPLAN/OPORD.
3. (U) Execution.
 - a. (U) Concept of the Operation.
 - (1) (U) If you are operating as a unit, squad, or other formation, follow the orders of your leaders.
 - (2) (U) Nothing in these rules negates your inherent right to use reasonable force to defend yourself against dangerous personal attack.
 - (3) (U) These rules of self-protection and rules of engagement are not intended to infringe upon your right of self defense. These rules are intended to prevent indiscriminate use of force or other violations of law or regulation.
 - (4) (U) Commanders will instruct their personnel on their mission. This includes the importance of proper conduct and regard for the local population and the need to respect private property and public facilities. The *Posse Comitatus Act* does not apply in an overseas

area. Expect that all missions will have the inherent task of force security and protection.

- (5) (U) ROE cards will be distributed to each deploying soldier (see Annex A to this appendix).

b. (U) Rules of Self-Protection for all Soldiers.

- (1) (U) US forces will protect themselves from threats of death or serious bodily harm. Deadly force may be used to defend your life, the life of another US soldier, or the life of persons in areas under US control. You are authorized to use deadly force in self-defense when—

- (a) (U) You are fired upon.

- (b) (U) Armed elements, mobs, and/or rioters threaten human life.

- (c) (U) There is a clear demonstration of hostile intent in your presence.

- (2) (U) Hostile intent of opposing forces can be determined by unit leaders or individual soldiers if their leaders are not present. Hostile intent is the threat of imminent use of force against US forces or other persons in those areas under the control of US forces. Factors you may consider include—

- (a) (U) Weapons: Are they present? What types?

- (b) (U) Size of the opposing force.

- (c) (U) If weapons are present, the manner in which they are displayed; that is, are they being aimed? Are the weapons part of a firing position?

- (d) (U) How did the opposing force respond to the US forces?

- (e) (U) How does the force act toward unarmed civilians?

- (f) (U) Other aggressive actions.

- (3) (U) You may detain persons threatening or using force which would cause death, serious bodily harm, or interference with mission accomplishment. You may detain persons who commit criminal acts in areas under US control. Detainees should be given to military police as soon as possible for evacuation to central collection points (see paragraph d below).

c. (U) Rules of Engagement. The relief property, foodstuffs, medical supplies, building materials, and other end items belong to the relief agencies distributing the supplies until they are actually distributed to the populace. Your mission includes safe transit of these materials to the populace.

- (1) (U) Deadly force may be used only when—

- (a) (U) Fired upon.

- (b) (U) Clear evidence of hostile intent exists (see above for factors to consider to determine hostile intent).

(c) (U) Armed elements, mobs, and/or rioters threaten human life, sensitive equipment and aircraft, and open and free passage of relief supplies.

(2) (U) In situations where deadly force is not appropriate, use the minimum force necessary to accomplish the mission.

(3) (U) Patrols are authorized to provide relief supplies, US forces, and other persons in those areas under the control Of US forces. Patrols may use deadly force if fired upon or if they encounter opposing forces which evidence a hostile intent. Nondeadly force or a show of force should be used if the security of US forces is not compromised by doing so. A graduated show of force includes—

(a) (U) An order to disband or disperse.

(b) (U) Show of force/threat of force by US forces that is greater than the force threatened by the opposing force.

(c) (U) Warning shots aimed to prevent harm to either innocent civilians or the opposing force.

(d) (U) Other means of nondeadly force.

If this show of force does not cause the opposing force to abandon its hostile intent, consider if deadly force is appropriate.

(4) (U) Use of barbed wire fences is authorized.

(5) (U) Unattended means of force (for example, mines, booby traps, trip guns) are **not** authorized.

(6) (U) If US forces are attacked or threatened by unarmed hostile elements, mobs, and/or rioters, US forces will use the minimum amount of force reasonably necessary to overcome the threat. A graduated response to unarmed hostile elements may be used. Such a response can include—

(a) (U) Verbal warnings to demonstrators in their native language.

(b) (U) Shows of force, including the use of riot control formations (see Annex A for information on using RCAs).

(c) (U) Warning shots fired over the heads of the hostile elements.

(d) (U) Other reasonable uses of force, to include deadly force when the element demonstrates a hostile intent, which are necessary and proportional to the threat.

(7) (U) All weapons systems may be employed throughout the area of operations unless otherwise prohibited. The use of weapons systems must be appropriate and proportional, considering the threat.

(8) (U) US forces will not endanger or exploit the property of the local population without their explicit approval. Use of civilian property will usually be compensated by contract or other form of payment. Property that has been used for the purpose of hindering our mission will be confiscated. Weapons may be confiscated and demilitarized if they are used to interfere with the mission of US forces (see rule (10) below).

- (9) (U) Operations will not be conducted outside of the landmass, airspace, and territorial seas of Somalia. However, any USCENTCOM force conducting a search and rescue mission shall use force as necessary and intrude into the landmass, airspace, or territorial sea of any county necessary to recover friendly forces.
 - (10) (U) Crew-served weapons are considered a threat to US forces and the relief effort whether or not the crew demonstrates hostile intent. Commanders are authorized to use all necessary force to confiscate and demilitarize crew-served weapons in their area of operations.
 - (a) (U) If an armed individual or weapons crew demonstrates hostile intentions, they may be engaged with deadly force.
 - (b) (U) If an armed individual or weapons crew commits criminal acts but does not demonstrate hostile intentions, US forces will use the minimum amount of necessary force to detain them.
 - (c) (U) Crew-served weapons are any weapon system that requires more than one individual to operate. Crew-served weapons include, but are not limited to tanks, artillery pieces, anti-aircraft guns, mortars, and machine guns.
 - (11) (U) Within those areas under the control of US forces, armed individuals may be considered a threat to US forces and the relief effort, whether or not the individuals demonstrate hostile intent. Commanders are authorized to use all necessary force to disarm and demilitarize groups or individuals in those areas under the control of US forces. Absent a hostile or criminal act, individuals and associated vehicles will be released after any weapons are removed/demilitarized.
- d. (U) Use of riot control agents (RCAs). Use of RCAs requires the approval of CJTF. When authorized, RCAs may be used for purposes including, but not limited to—
- (1) (U) Riot control in the division area of operations, including the dispersal of civilians who obstruct roadways or otherwise impede distribution operations after lesser means have failed to result in dispersal.
 - (2) (U) Riot control in detainee holding areas or camps in and around material distribution or storage areas.
 - (3) (U) Protection of convoys from civil disturbances, terrorists, or paramilitary groups.
- e. (U) Detention of Personnel. Personnel who interfere with the accomplishment of the mission or who use or threaten deadly force against US forces, US or relief material distribution sites, or convoys may be detained. Persons who commit criminal acts in areas under the control of US forces may likewise be detained.
- (1) (U) Detained personnel will be treated with respect and dignity.
 - (2) (U) Detained personnel will be evacuated to a designated location for turnover to military police.

(3) (U) Troops should understand that any use of the feet in detaining, handling or searching Somali civilians is one of the most insulting forms of provocation.

4. (U) Service Support. Basic OPLAN/OPORD.

5. (U) Command and Signal. Basic OPLAN/OPORD.

Acknowledge

ARNOLD
MG

OFFICIAL
SMITH
Staff Judge Advocate
Annex A
ROE Card

Annex A

ROE Card

Rules of Engagement Joint Task Force for Somalia Relief Operations Ground Forces

Nothing in these rules of engagement limits your right to take appropriate action to defend yourself and your unit.

1. You have the right to use force to defend yourself against attacks or threats of attack.
2. Hostile fire may be returned effectively and promptly to stop a hostile act.
3. When US forces are attacked by *unarmed* hostile elements, mobs, and/or rioters, US forces should use the minimum force necessary under the circumstances and proportional to the threat.
4. You may not seize the property of others to accomplish your mission.
5. Detention of civilians is authorized for security reasons or in self-defense.

Remember

- The United States is **not** at war.
- Treat all persons with dignity and respect.
- Use minimum force to carry out the mission.
- Always be prepared to act in self-defense.

Rules of Engagement for Operation Provide Comfort¹ (As Authorized by JCS [EUCOM Dir 55-47])

1. All military operations will be conducted in accordance with the laws of war.
2. The use of armed force will be utilized as a measure of last resort only.
3. Nothing in these rules negates or otherwise overrides a commander's obligation to take all necessary and appropriate actions for his unit's self-defense.
4. US forces will not fire unless fired upon unless there is clear evidence of hostile intent.

Hostile Intent - The threat of imminent use of force by an Iraqi force or other foreign force, terrorist group, or individuals against the United States, US forces, US citizens, or Kurdish or other refugees located

¹ These rules of engagement were extracted from the Rules of Engagement Card carried by all coalition soldiers.

above the 38th parallel or otherwise located within a US or allied safe haven refugee area. When the on-scene commander determines, based on convincing evidence, that **hostile intent** is present, the right exists to use proportional force to deter or neutralize the threat.

Hostile Act - Includes armed force directly to preclude or impede the missions and/or duties of US or allied forces.

5. Response to hostile fire directly threatening US or allied care shall be rapid and directed at the source of hostile fire using only the force necessary to eliminate the threat. Other foreign forces as (such as reconnaissance aircraft) that have shown an active integration with the attacking force may be engaged. Use the minimum amount of force necessary to control the situation.

6. You may fire into Iraqi territory in response to hostile fire.

7. You may fire into another nation's territory in response to hostile fire only if the cognizant government is unable or unwilling to stop that force's hostile acts effectively or promptly.

8. Surface-to-air missiles will engage hostile aircraft flying north of the 36th parallel.

9. Surface-to-air missiles will engage hostile aircraft south of the 36th parallel only when they demonstrate hostile intent or commit hostile acts. Except in cases of self-defense, authorization for such engagements rests with the designated air defense commander. Warning bursts may be fired ahead of foreign aircraft to deter hostile acts.

10. In the event US forces are attacked or threatened by unarmed hostile elements, mobs, or rioters, the responsibility for the protection of US forces rests with the US commanding officer. The on-scene commander will employ the following measures to overcome the threat:

a. Warning to demonstrators.

b. Show of force, including the use of riot control formations.

c. Warning shots fired over the heads of hostile elements.

d. Other reasonable use of force necessary under the circumstances and proportional to the threat.

11. Use the following guidelines when applying these rules:

a. Use of force only to protect lives.

b. Use of minimum force necessary.

c. Pursuit will not be taken to retaliate; however, immediate pursuit may begin and continue for as long as there is an immediate threat to US forces. In the absence of JCS approval, US forces should not pursue any hostile force into another nation's territory.

d. If necessary and proportional, use all available weapons to deter, neutralize, or destroy the threat as required.

APPENDIX E

Sample Campaign Plan

(SECURITY CLASSIFICATION)

Copy No. ____ of ____ copies
Issuing Headquarters
Place of Issue
Date/Time Group of Signature

PEACE OPERATIONS CAMPAIGN PLAN: (Number or Code Name)

Reference: Maps, charts, and other relevant documents.

COMMAND RELATIONSHIPS. Briefly describe the command organization (composition and relationship) for the campaign. Is it UN-sponsored with a single force commander? Is the US in support? OPCON? Is it non-UN sponsored with a single headquarters or dual headquarters for military and political activities? Is there a distinct command arrangement for US observers? Will NGOs and PVOs be in theater? How will they be addressed?

1. Situation. Briefly describe the situation that the campaign plan addresses. Identify the related mandate as appropriate and any agreements, cease-fires, or truce arrangements.

a. Strategic Guidance. Summarize the force commander's directives, sanctions, or other measures or directives of higher authority that apply to the plan.

(1) Strategic Direction. Specify UN or non-UN direction for the situation in the theater, theater operations, or designated area for operations.

(2) Strategic Objectives and Tasks Assigned to the Command. Specify which tasks apply: preventive deployment, peacekeeping, peace enforcement, supervision of truces, prisoner-of-war exchanges, demilitarization and demobilization, protection of humanitarian assistance, guarantee or denial of movement.

(3) Constraints. Address actions that are prohibited or required by higher authority (ROE, SOFA/SOMA, TOR, legal, financial, political, identification of forces, mandate, jurisdictional, and so forth). Annexes may expand this information.

b. Belligerent Data. Summarize intelligence data or information.

(1) Composition, location, disposition, movements, and strengths of all factions, political groups, belligerent groups, and local or regional support that can influence the campaign.

(SECURITY CLASSIFICATION)

(SECURITY CLASSIFICATION)

(2) Strategic concept (if known), to include belligerent intentions and conditions that could violate the peace (border crossings, entering demilitarized zones, initiation of hostilities, acts of terrorism, and so forth).

(3) Major belligerent objectives, root causes of the conflict, cause and effect relationships of each side to agree to peace, each side's strategic and operational objectives.

(4) Operational and sustainment capabilities of probable belligerent COAs.

(5) Belligerent leadership patterns and idiosyncrasies.

(6) Vulnerabilities and sensitivities; key cultural, religious, ethnic characteristics, beliefs, values, attitudes.

(7) Centers of gravity; main source of belligerent power or weakness.

NOTE: Identify assumed information as such. Reference the intelligence or information operations annex for more detailed information.

c. Friendly Forces. Specify information on friendly or neutral forces or entities not assigned that may directly affect the command, to include centers of gravity or friendly or neutral forces.

(1) Intent of higher, adjacent, and supporting US commands.

(2) Intent of higher, adjacent, and supporting UN or other national contingent commands or elements.

(3) Intent, philosophy, and modus operandi of NGOs and PVOs, UNHCR, or other players of this nature.

d. Assumptions. Include assumptions applicable to the plan as a whole.

2. Mission. Specify tasks of the command and the purposes and relationships to achieve the strategic objectives. Does the mission entail support to diplomacy, peacekeeping efforts, observer or peacekeeping forces, or peace enforcement measures.

3. Operations.

a. Strategic Concept. Based on the relevant major elements of UN, US, or multinational strategy, provide a broad concept for deployment, employment, and sustainment of major forces in the command.

(1) Command organization. What is the force mandate?

(2) Area organization. What is the size and nature of the area that the force must control? Organized by national contingents? Major elements of the force?

(3) Campaign objectives.

(4) Phases, major events, or major operations of the campaign.

(5) Timing. Is the duration of the campaign mandated? Are phases time-sequenced?

(SECURITY CLASSIFICATION)

(SECURITY CLASSIFICATION)b. Phase I. (Timing for Phase).

(1) Operational Concept. Provide operational objectives, scheme for conducting the mission, for example, separating belligerent parties or interpositioning the force between belligerent parties, and timing for this phase.

(2) Forces Required by Function or Capability. Specify combat, combat support, or combat service support forces. Will forces be committed as part of a joint, UN, or multinational force? Unilaterally?

(3) Tasks. Specify tasks of subordinate commands and contingents and tasks for forces, as applicable. Describe tasks for subordinate non-US and US contingent, sector, and unit forces.

(4) Reserve Forces. Specify location and composition.

(5) Psychological. Describe psychological operations that might affect the campaign. Refer to detailed annex.

(6) Civil Affairs. Describe civil affairs operations and organization that might affect the overall campaign. Refer to detailed annex.

(7) Public Affairs. Describe public affairs operations and organization. Refer to detailed annex.

c. Phases II - IV. Provide information as stated above for each subsequent phase with a separate phase for each step in the subordinate campaign at the end of which a major reorganization of forces may be required and another significant action initiated. Consider transitions and termination operations and postconflict activities and requirements. Consider evacuation activities if appropriate. Refer to detailed annexes.

d. Coordinating Instructions. Provide instructions applicable to two or more phases or multiple elements of the force. Include CMOC organization, composition, and geographic distribution, along with general liaison requirements. Refer to detailed annexes.

4. Logistics. Provide a brief, broad statement of the sustainment concept of the campaign, with information and instructions applicable to the subordinate campaign by phase. Logistics phases must be concurrent with operational phases. This information may be issued separately and referenced here. At a minimum, this paragraph addresses:

a. Assumptions (including UN or multinational agreements).

b. Logistics concept of operation; for example, nodes and hubs, LOGCAP, LSE.

c. Local acquisition and contracting, host nation, or other local support.

d. Finance and exchange of foreign currency. Reimbursement procedures for UN operations.

e. Receipt, storage, and issue of all classes of supply.

(SECURITY CLASSIFICATION)

(SECURITY CLASSIFICATION)

- f. Transportation.
- g. Mortuary affairs.
- h. Food services.
- i. Water processing, storage, and issue.

5. Command and Signal.

a. Command.

(1) Command Relationships. Provide a general statement of the command relationships for the campaign or portions thereof. Show the status, authority, and responsibilities of the force commander, subordinate commander (if applicable), national contingent commanders, sector commanders, and unit commanders.

(2) Delegation of Authority.

b. Signal.

(1) Communications. Plan communications. If UN-sponsored, determine communications among forces and UN headquarters. If non-UN-sponsored, determine joint force established communications links. Centralized communications are the responsibility of a designated, single, national contingent. Each national contingent is responsible for its own internal communications system.

(2) Electronics. Plan electronics systems (may refer to a standard plan or may be contained in an annex). Include electronic policy and such other information as may be appropriate.

Signed _____
(Commander)

ANNEXES: As required

DISTRIBUTION:

(SECURITY CLASSIFICATION)

Glossary

AAFES	Army and Air Force Exchange System
ADA	air defense artillery
ADCON	administrative control
administrative control	the direction or exercise of authority necessary to fulfill military department statutory responsibilities for administration and support; ADCON may be delegated to and exercised by service commanders at any echelon at or below the service component command; the secretaries of military departments are responsible for the administration and support of their forces assigned or attached to unified commands; secretaries fulfill this responsibility by exercising ADCON through the service component commander of the unified command; ADCON is subject to the command authority of the combatant commander
AFCS	Army facilities component system
AIDS	acquired immune deficiency syndrome
AIFC	American Friends of Action Internationale Contre La Faim
alliance	the result of formal agreements between two or more nations for broad, long-term objectives; see also <i>multinational</i>
AMC	Army Materiel Command
antiterrorism	defensive measures used to reduce the vulnerability of individuals and property to terrorist acts, to include limited response and containment by local military forces; also called <i>AT</i>
AO	area of operations
AOFDA	US Aid Office for Foreign Disaster Assistance
ARFOR	Army force
ARL	airborne reconnaissance low
armistice	in international law, a suspension or temporary cessation of hostilities by agreement between belligerent powers

Army facilities components system	the Army engineer's construction, execution, and logistics system in support of OCONUS contingency facility requirements; it provides detailed engineer theater planning data, austere designs consistent with joint construction standards, and logistics data for construction bills of material that are available in TMs 5-301 through 5-304
ARSOF	Army special operations forces
ASD(ISA)	Assistant Secretary of Defense for International Security Affairs
ASD(S&R)	Assistant Secretary of Defense for Strategy and Requirements
ASD(SO/LIC)	Assistant Secretary of Defense for Special Operations and Low-Intensity Conflict
branch	a contingency plan (an option built into the basic plan) for changing the disposition, orientation, or direction of movement of the force
buffer zone	the space controlled by the peace operations force that assures the specified parameters (as determined by METT-T, ROE, range of the belligerent's direct and indirect weapons systems, and commander's intent) and degree of risk will not be exceeded
CA	civil affairs
CADST	civil affairs direct support team
CAO	chief administrative officer
CARE	Cooperative for American Relief Everywhere, Incorporated
center of gravity	the hub of all power and movement upon which everything depends; that characteristic, capability, or location from which enemy and friendly forces derive their freedom of action, physical strength, or the will to fight
CID	criminal investigation division
CINC	commander-in-chief
CINCLANT	commander-in-chief, Atlantic Fleet
CIS	common item support

civil affairs	the activities of a commander that establish, maintain, influence, or exploit relations between military forces and civil authorities, both governmental and nongovernmental, and the civilian population in a friendly, neutral, or hostile area of operations in order to facilitate military operations and consolidate operational objectives; civil affairs may include performance by military forces of activities and functions normally the responsibility of local government; these activities may also occur, if directed, in the absence of other military operations
civil-military operations	the complex of activities in support of military operations embracing the interaction between the military force and civilian authorities fostering the development of favorable emotions, attitudes, and behavior in neutral, friendly, or hostile groups
CLO	chief logistics officer
CMOC	civil-military operations center
COA	course of action
coalition	an ad hoc agreement between two or more nations for a common action
combat service support	the focus of logistics at the tactical level of war; the synchronization of essential functions, activities, and tasks necessary to sustain soldiers and their weapon systems in an area of operations; includes but is not limited to that support rendered by service support troops to arm, fuel, fix, move, man, and sustain soldiers and their equipment
combat support	operational assistance for combat elements
combatant command	the command authority over assigned forces vested in the commanders of unified commands by Title X, US Code, Section 164, or as directed by the President in the Unified Command Plan (UCP); COCOM provides full authority to organize and employ commands and forces as the combatant commander considers necessary to accomplish assigned missions; COCOM is not transferable; the CINC uses COCOM to organize and employ his commands and forces, assign tasks, designate objectives, and give authoritative direction over all aspects of military operations, joint training, and logistics necessary to accomplish the assigned missions; the CINC normally exercises COCOM through his service component commanders
combatting terrorism	actions taken to oppose terrorism throughout the entire threat spectrum, including antiterrorism—defensive measures taken to reduce vulnerability to terrorist acts—and counterterrorism—offensive measures taken to prevent, deter, and respond to terrorism

combined arms	application of several arms, such as infantry, armor, artillery, and aviation
command	constitutes the authority to issue orders covering every aspect of military operations and administration; the sole source of legitimacy for US commanders originates from the US constitution, federal law, and the Uniform Code of Military Justice and flows from the President to the lowest US commander in the field; the chain of command, from the President to the lowest commander in the field, remains inviolate (Presidential Decision Directive 25)
COMSEC	communications security
conflict termination	the process and period during which military forces transition from active combat operations to postconflict activities and from postconflict activities to redeployment
conflict	the period characterized by confrontation and the need to engage in hostilities other than to secure strategic objectives
constraint	limitations placed on the command by a higher command; constraints restrict freedom of action for planning a mission by stating what must be done
coordinating authority	a consultation relationship between commanders, but not an authority to exercise control; the CINC and other subordinate commanders designate coordinating authority to assist during planning and preparation for actual operations; the CINC specifies coordinating authority to foster effective coordination; however, coordinating authority does not compel any agreements; within the parameters set by the CINC's organization of the theater and the command relationships that he establishes, the Army organizes itself to best accomplish its missions; the CINC has the authority to direct certain Army organizational options but normally leaves internal Army organization and command relationships to the ASCC
COSCOM	corps support command
counterintelligence	information gathered and activities conducted to protect against espionage, other intelligence activities, sabotage, or assassinations conducted for or on behalf of foreign powers, organizations, persons or international terrorist activities, but not including personnel, physical, document, or communications security programs
counterterrorism	offensive measures taken to prevent, deter, and respond to terrorism
CRS	community relations service
CS	combat support

CSCE	Conference on Security and Cooperation in Europe
CSS	combat service support
CTC	combat training center
CTF	combined task force
CVS	commercial vendor services
demilitarized zone	in contrast to buffer zones, demilitarized zones are not normally occupied by third-party presence but are patrolled by observer teams or surveyed from observation posts; DMZs are created to neutralize certain areas from military occupation and activity; generally speaking, they are areas which are claimed by both sides and where control by one could constitute a direct threat to the other
DIA	Defense Intelligence Agency
direct liaison authorized	the authority granted by a commander at any level to a subordinate to directly coordinate an action with a command or agency within or outside the command; DIRLAUTH is a coordination relationship, not an authority through which command is exercised
DIRLAUTH	direct liaison authorized
DMZ	demilitarized zone
doctrine	fundamental principles by which military forces guide their actions in support of national objectives; doctrine is authoritative but requires judgment in application
DOD	Department of Defense
DOS	Department of State
DPKO	department of peacekeeping operations
DSAA	Defense Security Assistance Agency
end state	military end state includes the required conditions that, when achieved, attain the strategic objectives or pass the main effort to other instruments of national power to achieve the final strategic end state; that end state describes what the NCA wants the situation to be when operations conclude-both military operations, as well as those where the military is in support of other instruments of national power; in the peace operations context, end state includes the political and military conditions described by the authorizing power as the objective of peace operations

FAA	Foreign Assistance Act
FALD	field administration and logistics division
FAO	Food and Agricultural Organization
FEMA	Federal Emergency Management Agency
FIN	Finland
FLSG	force logistics support group
force protection	security program designed to protect soldiers, civilians employees, family members, facilities, and equipment in all locations and situations; accomplished through planned and integrated application of combatting terrorism, physical security, operations security, personal protective services; supported by intelligence, counterintelligence, and other security programs
force projection	the movement of military forces from CONUS or a theater in response to requirements of war or operations other than war; force-projection operations extend from mobilization and deployment of forces, to redeployment to CONUS or home theater, to subsequent demobilization
foreign assistance	assistance ranging from the sale of military equipment to donations of food and medical supplies to aid survivors of natural and man-made disasters; US assistance takes three forms—development assistance, humanitarian assistance, and security assistance
fratricide/friendly fire	a circumstance applicable to persons accidentally killed or wounded or equipment accidentally or mistakenly damaged in military action by friendly forces actively engaged with the enemy while directing fire at a hostile force or what is thought to be a hostile force
FYROM	former Yugoslav Republic of Macedonia
HA	humanitarian assistance
health services	all services performed, provided, or arranged by the Army Medical Department to support, promote, improve, conserve, or restore the mental or physical well-being of military personnel
HOM	head of media
host nation	a nation that receives the forces and/or supplies of allied nations and/or NATO organizations to be located on, to operate in, or to transit through its territory
host nation support	civil and/or military assistance rendered by a nation to foreign forces within its territory during peacetime, times of crisis, emergencies, or war; assistance provided during war is based upon agreements mutually concluded between nations

HSS	health service support
humanitarian assistance	assistance provided by DOD forces, as directed by appropriate authority, in the aftermath of natural or man-made disasters to help reduce conditions that present a serious threat to life and property; assistance provided by US forces is limited in scope and duration and is designed to supplement efforts of civilian authorities who have primary responsibility for providing such assistance
HUMINT	human intelligence
IAPF	Inter-American Peace Force
IC	Irish Concern
ICRD	International Committee of the Red Cross
illum	illumination
IMC	International Medical Corps
INGO	international nongovernmental organizations
INS	Department of Immigration and Naturalization Service
intelligence	the product resulting from collection, processing, integration, analysis, evaluation, and interpretation of available information concerning foreign countries or areas
IPB	intelligence-preparation-of-the-battlefield
IRC	International Rescue Committee
ISE	intelligence support element
JAG	judge advocate general
JCS	Joint Chiefs of Staff
joint tactics, techniques, and procedures	actions and methods that implement joint doctrine and describe how forces are employed in joint operations; joint TTP are promulgated by the JCS
joint task force	a force composed of assigned or attached elements of two or more services and constituted by appropriate authority for a specific or limited purpose or missions of short duration
JOSE	joint operations support element

J-STARS	joint surveillance target attack radar system
JTF	joint task force
JTFCEM	joint task force contingency engineer manager
letter of assist	a contractual document issued by the UN to a government, authorizing it to provide goods or services to a peacekeeping operation; the UN agrees either to purchase the goods or services or authorizes the government to supply them subject to reimbursement by the UN
liaison	that contact or intercommunication maintained between elements or military forces to ensure mutual understanding and unity of purpose and action
LIC	low-intensity conflict
LNO	liaison officer
LOA	letter of assist
LOC	line of communication
LOGCAP	Logistics Civil Augmentation Program
logistics	<p>the process of planning and executing the movement and sustainment of forces to execute military operations; includes the design, development, acquisition, storage, movement, distribution, maintenance, evacuation, and disposition of materiel; logistics includes—</p> <ul style="list-style-type: none"> • acquisition, preparation, maintenance, equipping, movement, and health service support of personnel; • acquisition or furnishing of services; • acquisition, construction, maintenance, operation, and disposition of facilities; <p>logistics is an overarching function that must encompass the range of military operations; at the tactical level, logistics focuses on the traditional CSS functions of arming, fixing, fueling, manning, moving, and sustaining soldiers</p>
logistics support element	a multifaceted logistical organization that has a work force easily tailored to meet logistics requirements and can control the interface among strategic, operational, and tactical logistics
LPT	logistics-preparation-of-the-theater
LSCS	Logistics Support Command, Somalia
LSE	logistics support element
LWR	Lutheran World Relief, Incorporated

MARFOR	Marine force
MCC	movements control center
MEDCOM	medical command
METL	mission-essential task list
METT-T	mission, enemy, troops, terrain and weather, and time available
MFO	multinational force and observers
MINURSO	United Nations Mission for the Referendum in Western Sahara
MP	military police
MSF	Medicines Sans Frontiers
MSR	main supply route
MTT	mobile training teams
multinational	pertaining to activities of both alliance and coalition organizations
multinational operation	a collective term to describe military actions conducted by forces of two or more nations; typically conducted within structures of coalitions or alliances
MWR	morale, welfare, and recreation
nation assistance	diplomatic, economic, informational, and military cooperation between the US and the government of another nation, with the objective of promoting internal development and the growth of sustainable institutions within that nation; corrects conditions that cause human suffering and improves the quality of life of the nation's people
NATO	North Atlantic Treaty Organization
NBC	nuclear, biological, chemical
NCA	National Command Authorities
NEO	noncombatant evacuation operations
NGO	nongovernment organization
nongovernment organization	a professional association, foundation, multinational business or other group with an interest in improving the quality of life of people
NOR	Norway

NORD Nordic
NSC National Security Council
NSE national support element

OAS Organization of American States
OCONUS outside the continental United States
OMA operations and maintenance Army
ONUC United Nations Operations in the Congo
ONUMOZ United Nations Operation in Mozambique
ONUSAL United Nations Observer Mission in El Salvador
OOTW operations other than war
OPCON operational control
OPCOM operational command

**operational command
(NATO)**

used to assign missions or tasks to subordinate commanders, to deploy units, to reassign forces, and to retain or delegate OPCON and/or TACON as deemed necessary; OPCOM does not include responsibility for administration or logistics; OPCOM may denote the forces assigned to a commander

operational control (US)

as discussed in joint doctrine, operational control is a slightly broader authority than OPCOM; OPCON, in addition to the authorities of the NATO operational command, includes the authority to prescribe the chain of command; organize commands and forces; suspend or reassign officers; delineate functional responsibilities; and delineate geographic AORs; the CINC uses OPCON to delegate the most authority with which subordinates can direct all aspects of military operations and joint training needed to accomplish any assigned mission; a commander with OPCON may control forces from one or more services; OPCON does not normally include the authority to direct logistics, administration, discipline, internal organization, or unit training; during OPCON the service component commander retains this service authority

**operational control
(NATO)**

the authority delegated to a commander to direct forces assigned so that the commander may accomplish specific missions or tasks which are usually limited by function, time, or location; further includes the deployment of units concerned and the retention or

delegation of tactical control to those units; does not include authority to assign separate employment of components of concerned units; neither does it, of itself, include administrative or logistical control

operational control

(PDD 25) a subset of command given for a specific time frame or mission; includes the authority to assign tasks to US forces already deployed by the President and assign tasks to US units led by US officers; within the limits of operational control, a foreign UN commander *cannot* change the mission or deploy US forces outside the area of responsibility agreed to by the President, separate units, divide their supplies, administer discipline, promote individuals, or change the internal organization of units

operations other than war

military activities during peacetime and conflict that do not necessarily involve armed clashes between two organized forces

OPLAN operations plan

OPORD operations order

OPSEC operations security

PA public affairs

PAO public affairs officer

PDD Presidential decision directive

PDF Panamanian Defense Force

PE peace enforcement

peace operations an umbrella term that encompasses three types of activities; activities with predominantly diplomatic lead (preventive diplomacy, peacemaking, peace building) and two complementary, predominately military, activities (peacekeeping and peace-enforcement)

peace-building postconflict actions, predominately diplomatic, that strengthen and rebuild civil infrastructure and institutions in order to avoid a relapse into conflict

peace-enforcement the application of military force, or the threat of its use, normally pursuant to international authorization, to compel compliance with resolutions or sanctions designed to maintain or restore peace and order

peacekeeping	military operations undertaken with the consent of all major parties to the dispute, designed to monitor and facilitate implementation of an agreement (ceasefire, truce, etc.) and support diplomatic efforts to reach a long-term political settlement
peacemaking	a process of diplomacy, mediation, negotiation, or other forms of peaceful settlement that arranges ends to disputes and resolves issues that led to conflict
PHS	Public Health Service
PK	peacekeeping
preventive diplomacy	diplomatic actions taken in advance of a predictable crisis and aimed at removing the sources of conflict before violence erupts or to limit the spread of violence when it occurs
principles of war	the enduring bedrock of Army doctrine that provides general guidance for the conduct of war at the strategic, operational, and tactical levels
procedures	a standard and detailed course of action that describes how to perform a task
psychological operations	planned operations to convey selected information and indicators to foreign audiences to influence their emotions, motives, objective reasoning, and, ultimately, the behavior of foreign governments, organizations, groups, and individuals; the purpose is to induce or reinforce foreign attitudes and behavior favorable to the originator's objectives
PSYOP	psychological operations
PVO	private voluntary organization
QRF	quick reaction force
ROE	rules of engagement
rules of engagement	directives issued by competent military authority that delineate the circumstances and limitations under which US forces will initiate and/or continue combat engagement with other encountered forces
SAM	surface-to-air missile
SCF-UK	Save the Children Federation-UK

SECDEF	Secretary of Defense
SECSTATE	Secretary of State
security assistance	groups of programs authorized by the <i>Foreign Assistance Act of 1961</i> , as amended, and the <i>Arms Export Control Act of 1976</i> , as amended, or other related statutes by which the United States provides defense articles, military training, and other defense-related services by grant, loan, credit, or cash sales in furtherance of national policies and objectives
SF	Special Forces
SFODA	Special Forces operational detachments-A
SIGINT	signals intelligence
SJA	staff judge advocate
SO	special operations
SOF	special operations forces
SOFA	status of forces agreement
SOMA	status of mission agreement
SOP	standing operating procedures
special operations	actions conducted by specially organized, trained, and equipped military and paramilitary forces to achieve military, political, economic, or psychological objectives by nonconventional military means in hostile, denied, or politically sensitive areas; they are conducted in peace, conflict, and war, independently or in coordination with operations of general purpose forces; politico-military considerations frequently shape special operations, requiring clandestine, covert, or low-visibility techniques and oversight at the national level; special operations differ from conventional operations in degree of risk, operational techniques, mode of employment, independence from friendly support, and dependence on detailed operational intelligence and indigenous assets
specified command	a command with a broad, continuing mission under a single commander normally composed of forces from one service
split-based logistics	dividing logistics management functions so that only those functions absolutely necessary are deployed, allowing some management functions to be accomplished from CONUS or another theater
SRSG	special representative to the secretary general

STANAG	standardization agreement
status of forces agreement	an international agreement that demonstrates the legal relationship between the armed services of sending states and the host nation; determines a standard legal treatment and provides a basis for solving legal problems required by the presence of foreign forces abroad
strategy	the art and science of employing the armed forces and other elements of national power during peace, conflict, and war to secure national security
support	<p>relationships for one force to aid, assist, protect, or logistically support another force; the supporting force gives the needed support to the supported force; establishing supported and supporting relationships among components is a useful option to accomplish needed tasks; this concept applies equally to all dimensions of the joint force organized by the CINC; categories of support include—</p> <p><i>Mutual support</i> describes actions that units render one another against an enemy because of their assigned tasks, their positions relative to one another and to the enemy, and their inherent capabilities</p> <p><i>General support</i> provides designated support to a supported force as a whole and not to any particular subdivision thereof; the most centralized support relationship; for combat units, this relationship provides the most flexibility for influencing the battle during conduct of operations and is used when the enemy situation is unclear; more commonly used in the defense rather than the offense</p> <p><i>Direct support</i> provides designated support to a specific force and authorizes the supported force to directly seek this support; a supporting force is designated to directly assist a supported force; this is accomplished by providing support on a priority basis to the supported force; however, the supporting force may provide support to other forces when it does not jeopardize the mission or put at risk the supported force; authority to accomplish support of other than direct supported forces rests with the higher tactical or operational commander but also may be delegated as described by doctrine, the operations plan, or operations order; for example, this support includes the elements of a general support artillery brigade assigned a direct support mission and temporarily diverted to support a force other than the designated force</p> <p><i>Close support</i> is that action of the supporting force against targets or objectives sufficiently near the supported force as to require detailed integration or coordination of the supporting action with the fire, movement, or other actions of the supported force</p>
SWE	Sweden

SYG	secretary general
TACAIR	tactical air
TACON	tactical control
tactical command (NATO)	the authority delegated to a commander to assign tasks to forces under his command for the accomplishment of the mission assigned by higher authority; differs from TACON in that TACON involves only the necessary control of movements and maneuvers to accomplish a previously assigned mission
tactical control	the detailed and, usually, local direction and control of movements or maneuvers necessary to accomplish missions or tasks assigned; in general, the delegation of tactical control is only necessary when two or more units not under the same operational control are combined to form a cohesive tactical unit; a commander having tactical control is responsible for formulating the plan and issuing the necessary orders to the unit; the CINC uses TACON to limit the authority to direct the tactical use of combat forces; TACON is normally detailed and specifies local direction of movement and maneuver to accomplish an assigned task; TACON does not provide organizational authority or administration and support responsibilities; the service component normally retains this authority; both NATO and US joint doctrine share the same definition for TACON
tactics	the employment of units in combat; the ordered arrangement and maneuver of units in relation to one another and/or to the enemy in order to use their full potential; for example, a commander designates a unit as a reserve and plans for its use
techniques	the general and detailed methods used by troops and/or commanders to perform assigned missions and functions, specifically, the methods of using equipment and personnel; for example, a tactic of covering an obstacle with direct and indirect fires may be executed by emplacing machine guns on the flanks to fire down the length of the obstacle and mortars firing on the obstacle initially then beyond it to cutoff withdrawal of an opposing force
tenets	a basic truth held by an organization; the fundamental tenets of Army operations doctrine describe the characteristics of successful operations
TOR	terms of reference
total mission awareness	the ability of commanders at all levels to consider everything that affects their operation; applies to operations other than war and war

TSP	training support package
UN	United Nations
UNAVEM	United Nations Angola Verification Mission
UNCIVPOL	United Nations civilian police
UN-DMT	United Nations Disaster Management Team
UNDHA	United Nations Department of Humanitarian Affairs
UNDOF	United Nations Disengagement Observer Force
UNDP	United Nations Development Program
UNFICYP	United Nations Peacekeeping Force in Cyprus
UNGA	United Nations General Assembly
UNHCR	United Nations High Commissioner for Refugees
UNICEF	United Nations Children's Fund
unified command	a command with a broad, continuing mission under a single commander and composed of significant assigned components of two or more services
UNIFIL	United Nations Intervention Force in Southern Lebanon
UNIKOM	United Nations Iraq-Kuwait Observer Mission
UNITAF	unified task force
UNMIH	United Nations Mission in Haiti
UNMO	United Nations military observers
UNMOGIP	United Nations Military Observer Force in India and Pakistan
UNOMIG	United Nations Mission in Georgia
UNAMIR	United Nations Assistance Mission for Rwanda
UNOMIL	United Nations Observer Mission in Liberia
UNOMUR	United Nations Mission for Uganda-Rwanda
UNOSOM	United Nations Operations in Somalia
UNPROFOR	United Nations Protection Force
UNSC	United Nations Security Council

UNTSO	United Nations Truce Supervision Organization
USACIC	criminal investigation command
USAID	United States Agency for International Development
USCG	United States Coast Guard
USCINCCENT	United States Central Command
USD(A)	Under Secretary of Defense for Acquisition
USD(P)	Under Secretary of Defense for Policy
USDA	Department of Agriculture
USFORDOMREP	United States Forces Dominican Republic
USFORSOM	United States Forces, Somalia
USIA	United States Information Agency
USIS	United States Information Service
USYG	under secretary general
versatility	the ability of units to meet diverse challenges, shift focus, tailor forces, and move from one role or mission to another rapidly and efficiently
VIP	very important persons
war	a state of open and declared armed hostile conflict between political units such as states or nations; may be limited or general in nature
WFP	World Food Program
WHO	World Health Organization
WVRD	World Vision Relief and Development, Incorporated

References

SOURCES USED

Strategic Publications

National Military Strategy, January 1992.

National Security Strategy, July 1994.

Charter of the United Nations, 26 June 1945.

The Clinton Administration's Policy on Reforming Multilateral Peace Operations
(Presidential Decision Directive 25), May 1994

Public Law 79-264 (as amended), *The United Nations Participation Act of 1945*.

Joint, Multiservice, and Foreign Publications

Joint Publication 1-02, *Department of Defense Dictionary of Military and Associated Terms*,
23 March 1994.

Joint Publication 2-0, *Joint Doctrine for Intelligence Support to Operations*, 12 October 1993.

Joint Publication 3-0, *Doctrine for Joint Operations*, 9 September 1993.

Joint Publication 3-05, *Doctrine for Joint Special Operations*, 28 October 1992.

Joint Publication 3-07, *Joint Doctrine for Military Operations Other Than War*
(Final Draft), July 1994.

Joint Publication 3-07.1, *Foreign Internal Defense*, 20 December 1993.

Joint Publication 3-07.2, *Joint Tactics, Techniques, and Procedures (JTTP) for Antiterrorism*,
25 June 1993.

Joint Publication 3-07.3, *Joint Tactics, Techniques, and Procedures for Peacekeeping Operations*,
29 April 1994.

Joint Publication 3-10.1, *Joint Tactics, Techniques and Procedures (JTTP) for Base Defense*,
15 March 1993.

Joint Publication 3-53, *Doctrine for Joint Psychological Operations*, 30 July 1994.

Joint Publication 3-54, *Joint Doctrine for Operations Security*, 15 April 1994.

- Joint Publication 3-56, *Command and Control for Joint Operations*, (Proposed Final Publication) 21 January 1994.
- Joint Publication 3-57, *Doctrine for Joint Civil Affairs* (Proposed Final Publication), October 1993.
- Joint Publication 4-0, *Doctrine for Logistics Support of Joint Operations*, September 1992.
- Joint Publication 4-02.1, *Health Support Logistics in Joint Operations*, 15 January 1991.
- Joint Publication 4-04, *Joint Doctrine for Civil Engineering Support*, (Proposed Final Publication) 24 June 1994.
- Joint Publication 5-0, *Doctrine for Planning Joint Operations* (Final Coordinating Draft), July 1994.
- Joint Publication 5-00.1, *Joint Tactics, Techniques, and Procedures for Campaign Planning* (First Draft), 1 July 1994.
- Joint Publication 5-00.2, *Joint Task Force Planning Guidance and Procedures*, September 1991.
- FM 100-23-2/FMFRP X-XXX/USACOM Pam XX/NDC TACNOTE 3-07.52/ ACCP 50-XX/ USAFEP 50-XX/PACAFP 50-XX, *Multiservice Procedures for Humanitarian Assistance Operations* (Final Draft), March 1994.
- AJP-1, *Allied Joint Operations Doctrine*, First Draft.
- Strawman, *Tactics, Techniques, and Procedures for Peace Enforcement, Peacemaking, Peacekeeping, Humanitarian Assistance, Joint/Combined/Interagency Operations*, Center for Low-Intensity Conflict (CLIC), December 1992.
- British Military Doctrine* (Draft), 12 May 1994.
- Operations* (includes Peacekeeping and Wider Peacekeeping), Draft Chapter Seven, United Kingdom, Spring 1993.
- Draft Army Field Manual, *Wider Peacekeeping*, United Kingdom, (Fourth Draft Revised), August 1994.
- Quadripartite Study on Peace Support Operations*, United Kingdom, April 1993.
- Peacekeeping Pamphlet No 1, *Peace Support Operations*, Australian Defence Force, June 1993.
- The Blue Helmets: A Review of United Nations Peacekeeping*, Second Edition, New York, 1990. United Nations.
- UN Training Guidelines*, Summer 1993.
- Peacekeeper's Handbook*, International Peace Academy, New York, 1984.
- Expeditionary Forces Conducting Humanitarian Assistance and Disaster Relief Operations*, COMSURFARDEVGRU USMC TACMEMO (Draft), 1993.

Nordic UN Tactical Manuals, Volumes 1 and 2, 1992.

CFP 301 (Interim), *Land Force Peacekeeping Operations*, Canadian Force Publication, Spring 1993.

NATO Doctrine for Peace Support Operations, (Draft) 22 February 1994.

MC-327, *NATO Military Planning for Peace Support Operations (For Official Use Only).*

MC-319, *NATO Principles and Policies for Logistics.*

MC-326, *Medical Support Precepts and Guidance for NATO.*

MCM-CIJ-001-94, *NATO Commanders Authority Over Logistics Resources (new Annex A, MC-319).*

Draft Concept of Involvement of Army Units in Humanitarian and Peacekeeping Activities, French Army, 15 October 1992.

Army Publications

DA Circular 11-88-2, *Policies for the Sinai Multinational Force and Observers, 1 February 1988.*

DA Circular 11-90-4, *The Sinai Multinational Force and Observers, 10 August 1990.*

DA Pamphlet 27-1, *Treaties Governing Land Warfare, 7 December 1956.*

DA Pamphlet 700-15, *Logistics Support of United Nations Peacekeeping Forces, May 1986.*

FM 5-114, *Engineer Operation Short of War, 13 July 1992.*

FM 7-20, *The Infantry Battalion, 6 April 1992*

FM 7-85, *Ranger Unit Operations, 9 June 1987.*

FM 7-98, *Operations in Low Intensity Conflict, 19 October 1992.*

FM 8-10, *Health Services Support in a Theater of Operations. 1 March 1991.*

FM 8-42, *Medical Operations in Low Intensity Conflict, 4 December 1990.*

FM 8-55, *Planning for Health Service Support, 15 February 1985.*

FM 12-50, *US Army Bands, 6 September 1991.*

FM 19-4, *Military Police Battlefield Operations, 7 May 1993*

FM 19-5, *Civil Disturbances, 28 November 1985.*

FM 21-10, *Field Hygiene and Sanitation, 22 November 1988.*

FM 21-10-1, *Unit Field Sanitation Team, 11 October 1989.*

FM 21-11, *First Aid for Soldiers, 27 October 1988.*

- FM 27-10, *The Law of Land Warfare*, 18 July 1956.
- FM 27-100, *Legal Operations*, 30 September 1991.
- FM 31-20, *Doctrine for Special Forces Operations*, 20 April 1990.
- FM 33-1, *Psychological Operations*, 18 February 1993.
- FM 34-2, *Collection Management and Synchronization Planning*, 8 March 1994.
- FM 41-10, *Civil Affairs Operations*, 11 January 1993.
- FM 63-6, *Combat Service Support in Low-Intensity Conflict*, 21 January 1992.
- FM 90-4, *Air Assault Operations*, 16 March 1987.
- FM 90-8, *Counter guerrilla Operations*, 29 August 1986.
- FM 90-14, *Rear Battle*, 10 June 1985.
- FM 90-10-1, *An Infantrymen's Guide to Combat in Built-Up Areas*, 12 May 1993.
- FM 100-5, *Operations*, 14 June 1993
- FM 100-7, *Decisive Force: The Army in Theater Operations*, (Final Draft) 4 April 1994.
- FM 100-8, *Multinational Army Operations* (Draft), 4 April 1994.
- FM 100-16, *Army Operational Support* (Draft) 4 April 1994,
- FM 100-17, *Mobilization, Deployment, Redeployment, Demobilization*, 28 October 1992.
- FM 100-19/FMFM 7-10, *Domestic Support Operations*, 1 July 1993.
- FM 100-20/ AFP 3-20, *Military Operations in Low Intensity Conflict*, 5 December 1990.
- FM 100-25, *Doctrine for Army Special Operations Forces*, 12 December 1991.
- TRADOC Pamphlet 11-9. *Blueprint of the Battlefield* (with additional operations support of war functions integrated [draft]), 21 May 1991.
- TRADOC Pamphlet 25-34, *Desk Guide for Doctrine Writing*, 24 January 1992.
- TRADOC Pamphlet 525-56, *Planners Guide for Military Operations Other Than War*, 1 September 1993.
- Center for Army Lessons Learned (CALL) Newsletter, *Operations Other Than War: Peace Operations and Peace Enforcement*, December 1993.
- CALL Newsletter, *Fratricide Risk Assessment for Company Leadership*, March 1992.
- CALL Newsletter, *Force Protection (Safety)*, December 1993.
- CALL Newsletter, *Operations Other Than War: Humanitarian Assistance*, December 1992.

CALL Lessons Learned Report: *Operation Restore Hope*, 15 November 1993 (For Official Use Only).

XVIII Airborne Corps SOP in Support of the MFO, (Unofficial), 1993.

Wings for Peace: Airpower in Peacemaking Operations, Major W. Bruce Member, USAF, School of Advance Military Studies (SAMS) Monograph, 17 December 1992.

Operation Provide Comfort: A Model for Future NATO Operations, LTC John P. Cavanaugh, SAMS Monograph, 28 May 1992.

Does the Army Have A Peacekeeping Doctrine for the 1990s, Major Charles Taylor, SAMS Monograph, 29 June 1992.

Civilians in Support of Military Field Operations, J.E. Condrill, US Army War College Study Project, 15 April 1993.

The Relationship Between War and Peacekeeping, Major V.M., Robinson, USA, SAMS Monograph, 13 May 1992.

Conflict Termination: Integrating the Elements of Power in Today's Changing World, LTC W. Wodjakowski, USAWC Study Project, 15 April 1993.

Tactical Implications for Peacemaking in Ethnic Conflict, Major John M. Kelley, SAMS Monograph, 7 April 1993.

White Paper, *The Application of Peace Enforcement Operations at Brigade and Battalion*, US Army Infantry School, 31 August 1993.

Somalia Lessons Learned: Light Cavalry, US Army Armor Center, September 1993.

Peacekeeping: A Selected Bibliography, USAWC, January 1994.

Peace Operations Sourcebook, Inspector General DOD, 29 July 1994.

Recommended Readings

An Agenda For Peace: Preventative Diplomacy, Peacemaking, and Peacekeeping, Report of the Secretary General, Boutros Boutros Ghali, 17 June 1992.

A Draft Concept of Second Generation Multinational Operations 1993, John Mackinlay and Jarat Chopra, The Thomas J. Watson Institute for International Studies, Brown University, 1993.

Military Operations To Restore Peace and Maintain Order, COL John W. McDonald, USA (Ret), AUSA Land Power Essay, 1993.

"The United Nations in 1992: Problems and Opportunities," Brian Urquhart, *International Affairs*, 1992.

UN Peacekeepers: Soldiers with a Difference, A. Norton and T. Weiss, Foreign Policy Association, Spring 1990.

Partners for Peace: Strengthening Collective Security for the 21st Century, UN Association of the USA, October 1992, (Woolsey Commission Report).

“New Challenges for UN Military Operations: Implementing an Agenda for Peace,”
Thomas G. Weiss, *The Washington Quarterly*, Winter 1993.

The United Nations and Collective Security in the 21st Century, William J. Durch, Strategic Studies Institute, Army War College, February 1993.

Military Organization in the 1990's - A New Logic for War, R.M. Connaughton, Routledge, 1993.

Cooperating for Peace: The Global Agenda for the 1990s and Beyond, Gareth Evans, Allen, and Unwin, 1993.

Multinational Peacekeeping Operations: Background and Effectiveness, David R. Segal and Robert J. Waldman in *The Military in New Times: Adapting Armed Forces to a Turbulent World*, Ed. James Burk, Westview Press, 1993.

The Social Construction of Peacekeeping in America, David R. Segal, Mary Weschler Segal, and Dana P. Eyre, *Sociological Forum* 7, 1992.

Index

A

AC-130 aircraft, 42
acts of aggression, 2, 75
ADA. See air defense artillery
air assault operations, 7
airborne reconnaissance low, 39
air defense, 42
air defense artillery, 42
air defense forces, 8
air interdiction, 9, 43
airlift, 15
air surveillance, 39
alternatives to use of force, 17, 34
ambassador's authority, 29
ambassador/chief of mission, 78
AMC. See Army Materiel Command
American Council for Voluntary International Action (Interaction), 83
American Friends of Action Internationale Contre La Faim, 84
application of force, 15
arbitrator, 34
ARFOR operations, 7
armored forces, 40
arms control agreements, 5
Army Materiel Command, 14
Army special operations forces, 40
ARSOF. See Army special operations forces
artillery fires, 42
Assistant Secretary of Defense for Special Operations and Low-Intensity Conflict, 77

Assistant Secretary of Defense for Strategy and Requirements, 76
attack helicopter assets, 40
attack helicopters, 42
augmentation, 39
authority, 21

B

band support, 59
battle command, 43
battle laboratory experiments, 39
battlefield stabilization, 4
belligerent parties, 12, 39, 42
 centers of gravity, 46
 forcible separation of, 11
 lethality of weapons, 12
black-market activities, 46
Boxer Rebellion, 21
budgeting considerations. See funding considerations
buffer zones. See demilitarized zone

C

CA. See civil affairs
CADST. See civil affairs direct support teams
campaign plan, 31, 33
campaign plan, sample, 97–100
Catholic Relief Services, 84
cease-fire agreements, 42
cease-fires, 5
censuses, 5
centers of gravity, 33
chain of command, 65

Chapter VI operations. See peacekeeping
Chapter VII operations. See peace enforcement
charitable organizations, 37
Charter of the United Nations, 1
checkpoints, 17, 37, 38
chief administrative officer, 52
chief logistics officer, 52, 54
CINC. See commander-in-chief
civil affairs, 7, 11, 17, 39, 48
 direct support teams, 14, 58
 units, 40
civil authority, 6, 7
civilian
 casualties, 42, 59
 population, 42
civil-military operations, 14
civil-military operations center, 16, 26, 27
claims and liability, 49
coalition of forces, 21, 22
collateral damage, 35, 37, 42
combat actions, 6
combat forces, deployment of, 4, 7
combat functions, 39
 air defense, 42
 battle command, 43
 fire support, 42
 mobility and survivability, 43, 44
combat service support forces, 4, 14, 31, 47
combat support forces, 4, 14, 31
combat training centers, 38

combat units, 11
 combatant commander, 29
 combined arms assets, 38
 Combined Task Force (CTF) Provide Comfort. See Operation Provide Comfort
 command arrangements
 types of, 20
 with US as lead nation, 20
 with US in support, 20
 unilateral US, 20
 of US forces, 20
 command relationships, 21
 command, control, coordination, liaison, 20–30
 commanders
 combatant commander, 29
 commander-in-chief, 45
 and unity of effort, 16
 commercial vendor services, 60
 common goal, 23
 communications, 39, 43, 45
 commercial, 43
 security, 36
 computers, 39
 COMSEC. See communications security
 confidence-building. See battle-field stabilization
 conflict, 2
 conflict resolution, 9
 consensus, 20
 consensus-building, 16
 consent, 1, 12
 contingency forces, 46
 contingents, 55
 contracting elements, joint or multinational, 60
 contracting support, 60
 contractors, 43
 convoy escort, 7, 38, 40
 Cooperative for American Relief Everywhere, Incorporated, 84

coordinating authority, 21
 cordons and searches, 7
 corps support command, 58
 criminal investigation division, 38, 42
 crisis management, 42
 CS. See combat support
 CSCE. See Conference on Security and Cooperation in Europe
 CSS. See combat service support
 CTCs. See combat training centers

D

deception, 37
 de-escalation, commanders and, 17
 Defense Intelligence Agency, 47
 Defense Security Assistance Agency, 78
 demilitarization measures, 6
 demilitarized areas. See demilitarized zones
 demilitarized zone, 5, 11
 demobilization, 6
 demographic analysis, 45
 demographics, impact of, 46
 demonstrations, 17
 Department of Agriculture, 81
 Department Of Defense, 76
 Department of Defense, 29
 Department of Justice, 81
 Department of State, 29, 33, 78
 Department of Transportation, 81
 deployment, 65
 deterrence, 17, 34, 40
 DIA. See Defense Intelligence Agency
 digitization and information technology, 43
 dignity, preserving, 34
 disaster relief, 15

disease, 14
 disengagement, 5
 disengagement line. See demilitarized zone
 disengagement process, 4
 dislocated civilians, 14
 disputes, 2
 Doctors Without Borders/ Medicines Sans Frontiers, 84

E

early warning, 4
 early warning observers, 3
 economic reconstruction, 2
 elections, monitoring of, 5, 26
 electronic emissions, 9
 electronic spectrum, 43
 emergency drawdown of military department inventory stocks, 56
 end state, 12, 16
 enforcement of sanctions, 7, 8
 engineer forces, 43
 engineer operations, 44
 engineer unit Class IV acquisition and storage, 44
 environment, 37
 espionage, 36
 evacuation, of peacekeeping forces, 37
 exchange of prisoners of war, 5
 exchanging information, 5
 extract of the UN Charter, 75

F

face-saving measures, 34
 field artillery, 42
 finance elements, 60
 finance operations, 59
 financial support, 15
 Firefinder, 42
 fire support, 42
 fire support coordination, 42

fiscal considerations, 49
 fixed-wing operations, 43
 fixing, 58
 FLSG. See force logistics support group
 Food and Agriculture Organization of the United Nations, 83
 food distribution, 15, 46
 force, use of, 12, 33
 force commander, 64
 force commander's directive, 68
 force headquarters, and logistics, 54
 force logistics support group, 54
 force projection, 47
 force protection, 15, 36, 40
 force tailoring, 13, 38, 45
 force training, 38
 force-tailoring mix, 12
 forcible separation of belligerent parties, 6, 7
 Foreign Assistance Act, 56
 former Yugoslav Republic of Macedonia, 3, 21, 59
 fratricide, 37
 freedom of navigation, 8
 funding considerations, 41
 funding limitations, 49
 FYROM. See former Yugoslav Republic of Macedonia

G

Geneva Conventions, 49
 geopolitical situation, 14
 guarantee and denial of movement, 7, 8

H

HA. See humanitarian assistance
 health, 37
 helicopters, observation/scout, 42
 historical perspectives
 Boxer Rebellion, 21

United Nations Force in Cyprus 6
 Operation Able Sentry, 59
 Operation Provide Comfort, 10, 41
 Operation Restore Hope, 7, 38, 44, 49, 59
 Panama, 8
 psychological operations, 41
 United Nations Operation in the Congo, 7
 host nation, 14
 humanitarian assistance, 6, 7, 10, 14
 humanitarian relief, 3
 hunger, 14
 protection of, 8
 and Special Forces, 40

I

ICRC. See International Committee of the Red Cross
 Immigration and Naturalization Service 82
 impartiality, 1, 5, 12, 13, 33, 88
 incapacitant, use of 35
 incidents resulting in loss of life 35
 incoming and outgoing forces, sequencing of 33
 information. See intelligence
 infrastructure, analysis of 46
 inquisitiveness, 88
 integration, 29
 intelligence, 8, 39, 45
 analysis of, 45
 augmentation of staff, 45
 collection and synchronization planning, 47
 counterintelligence, 39
 dissemination of, 47
 foreign, 86
 human, 38
 for multinational peace operations, 47

officer, 45
 and Special Forces 40
 intelligence-preparation-of-the-battlefield 45
 intent 35
 interagency coordination, 29
 interagency operations, 29
 International Committee of the Red Cross 85
 International Federation of Red Cross and Red Crescent Societies, 85
 The International Medical Corps, 84
 International Red Cross Movement, 85
 International Rescue Committee, 84
 interoperability, 37, 42, 44
 investigation of complaints and violations, 5
 Irish Concern, 84

J

joint forces, 42
 joint headquarters, 8
 joint intelligence doctrine, 45
 joint operations support element, 45
 joint surveillance and target attack radar system 39
 joint task force commander 43
 joint task force contingency engineer manager 43
 JOSE. See joint operations support element
 J-STARS. See joint surveillance and target attack radar system
 JTFCEM. See joint task force contingency engineer manager

L

land forces, 10

- language
 orientation, 30
 linguistic assistance, 33
 qualifications, 30
 and Special Forces, 40
- laws of war, 48
- leader development, 87
- legal services, 60
- legitimacy, 1
- legitimizing authority, 16
- level
 of consent, 12, 13
 of force, 12, 13
- liaison, 5, 29, 39
 centers, 22
 and civil affairs units, 40
 officers 29, 37, 43, 58
 and Special Forces, 40
- light air defense artillery, 42
- lines of communication, 50
- linguistic assistance. See language
- LNOs. See liaison officers
- local authorities 42
- LOCs. See lines of communication
- LOGCAP. See Logistics Civil Augmentation Program
- logistics, 47, 50–60
 and civilian authorities or contractors, 51
 functions, 56–60
 intelligence, 9
 and multinational operations, 52
 and nongovernment organizations, 51
 and private voluntary organizations, 51
 and UN assessment teams, 50
 and United Nations operations, 52
- in UN missions, 50
- multinational support, 50
 shared, 52, 53
 support 15, 56
 training for, 50, 51
 transition of functions, 51
- Logistics Civil Augmentation Program 44
- logistics operations
 for contingents, 55
 multinational, 53
 planning, 52
- logistics-preparation-of-the-theater 50, 58
- logistics support element 14, 56, 57
- LPT. See logistics-preparation-of-the-theater
- LSE. See logistics support element
- Lutheran World Relief, Incorporated, 84
- ## M
- maintenance automation, 58
- maintenance. See fixing
- mandates 4, 5, 12, 31, 46, 64, 66
 Non-United Nations, 66
 United Nations, 66
- maneuver, 39
- maneuver warfare 40
- media coverage, 14
- mediation, 2
- mediation and negotiation, 34
- medical units, 58
- memoranda of agreement, 68
- METL. See mission-essential task list
- METT-T. See mission, enemy, terrain, troops, and time available
- MFO. See multinational force and observers
- military observer groups. See observers
- military police, 36, 42
- military staff committee, 62
- military support to diplomacy. See support to diplomacy
- military-civilian relationship, 16
- military-to-military relations, 2
- mine fields, 37
- minorities, 10
- mission analysis, 31
- mission, enemy, troops, terrain, and time available 12, 37, 39
- mission-essential task list, 86
- mobile training teams, 38
- mobility and survivability, 43
- monetary systems and currencies, 46
- monitors. See observers
- morale, 37
- morale, welfare, and recreation programs, 39
- movement
 and maneuver, 23
 control, 57
 inland, 58
- movements control center, multinational, 57
- MPs. See military police
- MSC. See United Nations Military Staff Committee
- MTTs. See mobile training teams
- multinational efforts, 21
- multinational force and observers, 4
- multinational forces, 42, 43
- multinational operations, 11, 43
 Boxer Rebellion, 21
 categories of, 21
 in Dominican Republic, 21
 effectiveness of, 21
- multinational partners, capabilities of, 23

N

nation assistance, 2
 National Command Authorities, 76
 national contingents. See contingents
 national law, 68
 National Military Strategy, iii
 National Security Council, 76
 NATO. See North Atlantic Treaty Organization
 natural disasters, 14
 negotiation, 2, 5, 6
 mediation, 5
 negotiators, 34
 teams, 39,
 neutrality, 36
 NGOs. See nongovernmental organizations
 night observation devices, 44
 night vision devices, 39
 night vision light-intensifier devices, 37
 no-fly zone, 8
 noncombat actions 6
 nongovernment organizations, 14, 15, 16, 16, 37, 41, 45, 47, 60, 76, 83
 North Atlantic Treaty Organization, 21, 26
 logistics doctrine, 56
 logistics principles, 55
 operations, 55
 NMS. See National Military Strategy

O

OAS. See Organization of American States
 observation
 and monitoring, 39
 and reporting, 86
 of truces and cease-fires, 4
 posts, 37, 40

observers, 4
 Office of the Secretary of Defense, 29
 offshore or regional coalition strike force, 4
 ONUC. See United Nations Operations in the Congo
 OOTW. See operations other than war
 OPCOM. See operational command
 OPCON. See operational control
 Operation Able Sentry, 21, 23
 Operation Nimrod Dancer, 8
 Operation Provide Comfort, 10, 21
 Operation Restore Hope, 21, 31.
 See also Somalia
 operational command, 21
 operational control, 21, 65
 operational environment, 1
 operational-level commanders, 13
 operational variables, 13
 Operations Desert Shield/Storm, 44
 operations other than war, principles of, 15
 operations security, 36, 48
 OPSEC. See operations security
 ordnance, 42
 ordnance, unexploded, 42
 Organization of African Unity, 26
 Organization of American States, 21

P

Pacific Settlement of Disputes, 75
 Panama Canal Treaty, 8
 patrolling and securing borders, 4
 PE. See peace enforcement
 peace building, 2
 peace enforcement, 2, 6, 13, 14, 36

and differences from peacekeeping, 12
 example of, 7
 forces, 7, 40
 intelligence function, 45
 missions, 7
 phases, 7
 peacekeeping, iii, 1, 2, 13
 and differences from peace enforcement, 12
 information officer, 45
 traditional, 5
 peacemaking, iii, 2
 peace operations
 doctrinal framework for, 1
 fundamentals of, 1
 legal aspects of, 66
 tenets of, 1
 the variables of, 1, 12, 13, 43
 peace operations principles, 1
 legitimacy, 18
 mandate and terms of reference, 15
 objectives, 15
 perseverance, 17-18
 restraint 17
 security 16
 unity of effort, 16
 peace treaties, 6
 personal awareness, 36
 personnel services, 59
 personnel vulnerabilities, 36
 photography, 36
 PK. See peacekeeping
 planners, engineer 43
 planning, 31
 plebiscites, 5
 political loyalties, 46
 population
 distribution, 46
 at large 14
 and resource control, 34

port authority, 57, 58
 postconflict activities, 33
 postoperations training, 38
 Presidential Selected Reserve Call-Up, 38
 preventive deployments 2, 3, 4
 preventive diplomacy 2
 Principles of Humanitarian Action in Armed Conflict, 28
 private voluntary organizations, 14, 15, 16, 26, 37, 41, 60, 76, 83
 professionalism, 88
 protected zone
 establishment and supervision of 7, 9
 example of, 10
 protection of humanitarian assistance 7
 psychological operations, 7, 11, 17, 40, 48
 PSYOP. See psychological operations
 public affairs, 17, 47, 48
 Public Health Service, 82
 public opinion, 33
 Purple Storm, 8
 PVOs. See private voluntary organizations

R

radars, 39, 42
 ranger forces, 40
 rationalization, standardization, interoperability, 22
 rebuilding physical infrastructures, 2
 Red Cross, 60
 referendums, 5
 refugees, 5, 10
 regional alliance, 51
 reimbursable items, 56
 reinforcement capability, 4
 relief organizations, 15

relief supplies, distribution of, 14
 religious beliefs, 46
 religious observances, 46
 religious support, 59
 reporting and monitoring, 4
 reserve components, 43
 resource management, 56
 respect, for multinational partners, 21
 restoration and maintenance of order and stability, 7
 restoring civil authority, 2
 restraint, 34
 rewards and penalties, 34
 riot batons, 35
 riot control agents, 35
 roadblocks, 17, 36, 38
 ROE. See rules of engagement
 RSI. See rationalization, standardization, interoperability
 rules of engagement, 15, 31, 35, 37, 42
 changes in, 35
 development of, 35
 dissemination of, 35
 execution of, 36
 in multinational operations, 35
 Operation Provide Comfort, 95
 Operation Restore Hope, 90
 ROE card for Somalia Joint Task Force, 95
 sample ROE, 90
 in varied circumstances, 35
 wargaming of, 35

S

safety, 37
 SAMs. See surface-to-air missiles
 sanctions, enforcement of, 6, 9
 Sand Fleas, 8
 satellites, 39

Save the Children Federation, 85
 scout aircraft, 39
 sea interdiction, 9
 sealift, 15
 seaport operations. See port authority
 Secretary of Defense, 76
 Secretary of State, 78
 security, 17, 37, 51
 assistance, 2
 measures, 37
 of main supply routes, 38
 operations, 7
 to threatened minorities, 3
 Security and Cooperation in Europe, 26
 self-defense, 34
 sensors, 39
 service judge advocate, 56
 SF. See Special Forces
 SFODA. See Special Forces operational detachments-A
 shows of force, 2, 17
 signal support, 43
 simultaneous application of combat power, 34
 sites, accommodations, and defensive positions, 36
 situational advantage, 39
 situational dominance, 13
 SJA. See staff judge advocate
 sniper threats, 37
 SOF. See Army special operations forces
 soldiers, sustaining, 58
 Somalia, 7, 21, 44. See also Operation Restore Hope
 Special Forces, 40
 Special Forces Operations Detachment A, 14
 special operations forces, 30
 special operations forces. See Army special operations forces

special operations units, 14
 split-based operations, 45
 staff judge advocate, 35
 STANAGs. See standardization agreements
 standardization agreements, 42
 standardized exchange systems, 47
 State Department, 78-80
 status of forces agreements, 66
 status of mission agreements. See status of forces agreements
 status-of-forces agreements, 59
 strategic context, 1
 supervision of truces 4, 5
 supplies
 automation of, 58
 distribution of, 41
 and services, 56
 support relationships, 21
 support to diplomacy, 2, 13
 peace building, 2
 peacemaking, 2
 preventive diplomacy, 2
 surface-to-air missiles, 42
 surveillance and communication capabilities, 4
 surveillance cameras. See warning devices
 sustainment training, 17

T

10th Mountain Division (Light Infantry), 31
 TACAIR. See tactical air
 TACOM. See tactical command
 TACON. See tactical control
 tactical air, 42
 tactical command, 21
 tactical control, 21
 tactical level decisions, 1
 tactical mobility, 4

tactical surveillance and monitoring, 3
 teamwork, 20, 38
 technology, 39
 terms of reference, 15, 31, 46, 65
 development process, for 65
 for US Forces Somalia, 69
 terrain, 37, 46. See also mission, enemy, terrain, troops, and time available
 terrorist activities, 45, 86
 thermal imagery devices, 44
 thermal sights, 39
 threats
 courses of action, 46
 evaluation of, 46
 to life, 14
 TOR. See terms of reference
 training 86–89
 peace enforcement, 87
 peacekeeping, 87
 predeployment, 86
 individual, 88
 sustainment, 88
 unit, 87
 training support packages, 38
 transition
 to peacekeeping, 33
 from one kind of operation to another, 31
 transportation 39, 44, 57
 treaties, 5
 troop units, 43
 truce supervisory forces, 5
 truces, 5
 TSPs. See training support packages

U

UAV. See unmanned aerial vehicles
 UN. See United Nations
 UN Charter. See Charter of the United Nations

UN SYG. See United Nations secretary general
 UNFICYP 6
 UNFICYP. See United Nations Force in Cyprus
 UNHCR. See United Nations High Commissioner for Refugees
 unilateral operations, 1, 20
 unit training, 87
 United Nations, 61-83
 chief procurement officer, 60
 Department of Humanitarian Affairs, 63, 82
 Department of Peacekeeping Operations, 62, 63
 Department of Political Affairs, 63
 Development Program, 83
 Disaster Management Team, 82
 Field Administration and Logistics Division, 64
 United Nations forces 15
 General Assembly, 61, 62
 as a legitimizing authority, 16
 Military Staff Committee, 62
 organization and functions of, 1, 61
 organizations, 82-83
 planning process, 64
 reimbursement to the US, 57
 secretariat, 62
 secretary general, 61
 Security Council, 61
 United Nations Children's Fund, 83
 United Nations Force in Cyprus, 6
 United Nations High Commissioner for Refugees, 41, 82
 United Nations Mandate Resolution, example of, 74
 United Nations Operation in Somalia. See Somalia

United Nations operations
 Kuwait and Iraq (1990-1991), 2
 Korea (1950-1953), 2
 The United Nations Participation Act of 1945, 15
 United Nations Task Force Security Operations, 32
 United Nations Truce Supervision Organization, 4
 United States Army Criminal Investigation Command, 51
 United States Government Organizations, 76-82
 Department of Defense, 76-78
 Department of State, 78-80
 Department of Agriculture, 81
 Department of Justice, 81
 Immigration and Naturalization Service, 82
 National Command Authorities, 76
 National Security Council, 76

Organization of American States, 22
 Public Health Service, 82
 United States Agency for International Development, 15, 29, 33, 80
 United States Aid Office for Foreign Disaster Assistance, 81
 United States Information Agency, 33, 81
 unity of command, 16
 unmanned aerial vehicles, 39
 UNSC. See United Nations Security Council
 UNTSO. See United Nations Truce Supervision Organization
 USAID. See US Agency for International Development
 use of force, 34
 USIA. See United States Information Agency
 USYGs. See United Nations under secretary generals

V

variables of peace operations, 13
 versatility, 1
 vulnerability to disaster, 15

W

warfighting skills, 6, 86
 warning devices, 46
 warnings 34
 weapons
 systems, 4, 12
 confiscation of, 38
 heavy, 9
 weather, 46
 withdrawal, 12
 withdrawal of belligerent forces, 5
 World Food Program, 83
 World Vision Relief and Development, Incorporated, 85

FM 100-23
30 DECEMBER 1994

By order of the Secretary of the Army:

GORDON R. SULLIVAN
General, United States Army
Chief of Staff

Official:

MILTON H. HAMILTON
Administrative Assistant to the
Secretary of the Army

DISTRIBUTION:

Active Army, USAR, and ARNG: To be distributed in accordance with DA Form 12-11E, requirements for FM 100-23 (Qty rqr block no 5347).

FM 100-23

[Date]

By order of the Secretary of the Army:

GORDON R. SULLIVAN

General, United States Army

Chief of Staff

Official:

MILTON H. HAMILTON

Administrative Assistant to the

Secretary of the Army

DISTRIBUTION:

Active Army, USAR, and ARNG: To be distributed in accordance with
DA Form 12-11E, requirements for FM 100-23 (Qty rqr block no).